

RESPONSE TO

Huawei Technologies

China – Global Furniture Catalogue

July 1st, 2016

Request for Proposal



Introduction

This document contains the **Steelcase Global Furniture Catalogue**. It is mandatory that it be read and used in conjunction with the Contracting and Procurement processes detailed within the Contracting and Procurement chapter.

The products illustrated on the following pages have been screened to ensure they meet ergonomic needs of users, provide enduring safety, quality and durability and project the Steelcase brand.

It is critical to understand that not all versions of the products which appear in the this catalogue may be suitable for use within all **Huawei Technologies offices** or within every project. Therefore, it is the responsibility of the specifier to assess specific project use and functional requirements along with the catalogue. Additionally, procurement of furniture requires use of the Furniture Specification Templates for each product to ensure that the correct version of each product are selected to meet the global requirements as well as the local project needs.

Only products which appear in the Steelcase Global Furniture Catalogue can be purchased for Huawei Projects. Any exceptions are product categories and product lines which are considered specialty use or out of this catalogue will be escalated to the Huawei's project teams. The categories contained within the catalogue are shown to the right

The regions identified for each product identify the regions where this product can be sold. This may not correlate to the region where the product is manufactured. The actual lead time for availability of each product must be obtained at the time of request.



Core Space

Work Points

- L-Shaped Workstations
- Bench Workstation
- Temporary Workstations
- Manager Office
- Quiet Rooms
- VIP Room

Meeting and Collaboration Core Space

Meeting Spaces

- Huddle Space – Small
- Huddle Space – Large
- Internal Meeting Room
- External Meeting Room
- Training Room
- Video Conference Room

Work Support Spaces

- Café
- Compactus Room
- Lockers
- Pedestals

Support Spaces

- Canteen
- Reception Area
- Pantry

Task & Visitor Seating

Catalogue Content

Steelcase Global Catalogue is divided into 5 different regions.

1. **China**
2. **Asia Pacific**
3. **Europe**
4. **Middle East & Africa**
5. **Americas**

We offer difference product ranges in different regions. Each region will propose it's local and global selections of furniture that will meet the closest requirements to Huawei's Office Playbook.

Details of each "space category" types proposed are described and divided into 5 areas:

- I. **WORK POINTS**
- II. **MEETING SPACES**
- III. **WORK SUPPORT SPACE**
- IV. **SUPPORT SPACES**
- V. **TASK & VISITOR SEATING**

Each space category above will have subsections based on Huawei's Office Playbook. Depending on the size of the office and the category of the country, in which the office is located, the different space category will be classified in each section.

Catalogue Content

Space category is divided into subsections below:

I. WORKPOINTS

Page 11

- L-Shaped Workstation Page 12 - 16
- Bench Workstation Page 18 - 23
- Temporary Workstation Page 24 - 25
- Manager Office Page 27 - 31
- Quiet Room Page 32
- VIP Area Page 33 - 54

II. MEETING SPACES

Page 55

- Huddle Space – Small Page 57 - 59
- Huddle Space – Large Page 60 - 65
- Enclosed Meeting Room (internal) Page 67 - 69
- Enclosed Meeting Room (External) Page 70 - 71
- Training Room Page 74 - 76
- Video Conference Room Page 77 - 79

III. WORK SUPPORT SPACES

Page 80

- Collaboration Area Page 81 - 95
- Locker Page 97 - 98
- Compactus Page 99 - 100
- Pedestal Page 101 - 102
- Worktools Page 103 - 104

IV. SUPPORT SPACES

Page 113

- Canteen Page 115 - 118
- Reception Area Page 119
- Pantry Page 120 - 124

V. TASK AND VISITOR SEATING

Page 125

TASK

- Low Page 127 - 128
- Medium Page 129 - 130
- High Page 131 - 132
- Premium Page 133 - 134
- Exclusive Page 135 - 136

VISITOR

- Low Page 137
- Medium Page 138
- High Page 139
- Premium Page 140

VI. STEELCASE CORPORATE CAPABILITIES

Page 146

- Introduction Page 147
- Proposed Team & Milestones Page 149
- Direct & Dealer Locations Page 158
- Plant Location Page 166
- Shipping Lead Times Page 167
- Sustainability Information Page 168

VII. DISCOUNTS & PRICING

Page 176

How to Use.

Majority of the space configuration is divided into:

- **Low** – most cost effective
- **Mid** – above average to low
- **High** – expensive
- **Premium** – most expensive

The ranks are differentiated by product cost, key features, quality and manufacturing origins. For example: If you require a low cost solution, please identify and pick category “low” as your selection.

Catalogue Content: Every Steelcase proposed configuration in this catalogue include detailed descriptions of:

- Product Features
- Sizes
- Manufacturing origin
- Design origin
- Lead time
- Color Finishes
- Sustainability Certifications
- Pricing/Cost

Disclaimer:

**** All product proposed are standard, any exceptions of product categories and product lines which are considered specialty use or out of this catalogue will be subjected to additional cost.**

Steelcase Product lines

WORKSTATIONS

CHINA

Lexicon
 Cost effective solution

FrameOne
 Mid End solution
 Available Globally

Sit2Stand
 High end solution
 Height Adjustable

APAC

Lexicon
 Cost effective solution

FrameOne
 Mid End solution
 Available Globally

Sit2Stand
 High end solution
 Height Adjustable

EUROPE

OttimaEco
 Cost effective solution

Kalidro
 Mid End solution

FrameOne
 High end solution
 Available Globally

Ology
 Premium solution
 Height Adjustable

MIDDLE EAST & AFRICA

OttimaEco
 Cost effective solution

Kalidro
 Mid End solution

FrameOne
 High end solution
 Available Globally

Ology
 Premium solution
 Height Adjustable

AMERICAS

Answer/Universal
 Cost effective solution

FrameOne
 Mid End solution
 Available Globally

Migration
 High end solution
 Height Adjustable

Series Bench
 Premium solution
 Height Adjustable

MEETING TABLES

Lexicon
 Cost effective solution

4.8
 Mid End solution

Convene
 High end solution

Lexicon
 Cost effective solution

4.8
 Mid/High End solution

Kalidro
 Cost effective solution

TouchDown
 Mid End Solution

FrameOne
 High End solution

Kalidro
 Cost effective solution

TouchDown
 Mid End Solution

FrameOne
 High End solution

Answer/Universal
 Cost effective solution

FrameOne
 Mid End solution

Groupwork
 High End solution

TRAINING TABLE

FlipTopTwin
 Cost effective solution

Verb
 Mid End solution

FlipTopTwin
 Cost effective solution

Verb
 Mid End solution

FlipTopTwin
 Cost effective solution

Verb
 Mid End solution

FlipTopTwin
 Cost effective solution

Verb
 Mid End solution

FlipTopTwin
 Cost effective solution

Verb
 Mid End solution

Steelcase Product lines

LOUNGE, SOFA

CHINA	APAC	EUROPE	MIDDLE EAST & AFRICA	AMERICAS
Cittern Sofa Cost effective solution	Cittern Sofa Cost effective solution	Visalia Cost effective solution	Visalia Cost effective solution	B Free Cost effective solution
B Free Cost effective solution	B Free Cost effective solution	B Free Cost effective solution	B Free Cost effective solution	Campfire Mid End solution
Campfire Mid End solution	Campfire Mid End solution	Lagunitas Mid End solution	Lagunitas Mid End solution	Media:scape Lounge High End solution
Media:scape Lounge High End solution	Media:scape Lounge High End solution	Media:scape Lounge High End solution	Media:scape Lounge High End solution	Millbrae Contract Premium solution
Millbrae Contract Premium solution	Millbrae Contract Premium solution	Millbrae Contract Premium solution	Millbrae Contract Premium solution	SW_1 Lounge Chair Premium solution
SW_1 Lounge Chair Premium solution	SW_1 Lounge Chair Premium solution	SW_1 Lounge Chair Premium solution	SW_1 Lounge Chair Premium solution	

TASK CHAIR

Personality Cost effective solution	Personality Cost effective solution	Reply / East side Cost effective solution	Reply / East side Cost effective solution	Reply Cost effective solution
Reply Mid End solution	Reply Mid End solution	Think Mid End solution	Think Mid End solution	Think Mid End solution
Think High End solution	Think High End solution	Leap High solution	Leap High solution	Leap High solution
Leap Premium solution	Leap Premium solution	Gesture Premium solution	Gesture Premium solution	Gesture Premium solution
Gesture Exclusive solution	Gesture Exclusive solution			

Steelcase Product lines

STORAGE

CHINA

UPV
Cost effective solution

UPSS
Mid End solution

APAC

UPV
Cost effective solution

UPSS
Mid End solution

EUROPE

SHARE IT
Cost effective solution

SHARE IT
Mid End solution

MIDDLE EAST & AFRICA

SHARE IT
Cost effective solution

SHARE IT
Mid End solution

AMERICAS

UNIVERSAL
Cost effective solution

EXECUTIVE COLLECTION

Impact
Wood/Veneer
Furnishing Item for
Private Office

Impact
Wood/Veneer
Furnishing Item for
Private Office

SHARE IT
Wood/Veneer
Furnishing Item for
Private Office

SHARE IT
Wood/Veneer
Furnishing Item for
Private Office

EE6
Wood/Veneer
Furnishing Item for
Private Office

Our Sustainability Standards

Our products carry a number of third-party verified certifications, reflecting our commitment to deliver on our promise.

These certifications program include:

- BIFMA level®
- China Environmental Label
- E1/E0
- SCS Indoor Advantage™
- PEP (Product Environmental Profiles)

**Please refer to our certifications enclosed.



BIFMA

Steelcase products conforms with one of the most stringent requirements which focuses on furniture comfort, safety, sustainability and durability standards. BIFMA (Business + Institutional Furniture Manufacturers Association) is also accredited by the American National Standards Institute (ANSI).



CHINA 10 CIRCLE ENVIRONMENTAL LABEL (中国十环认证)

China Ecolabel is one of the most renowned certification in Asia for being recognized as a green products. China 10 Circle is well respected and highly recognized for its stringent and holistic approach in sustainability and quality requirements, giving our clients and customers the added confidence when choosing Steelcase products. The certification is a type I Ecolabel certification following International standard ISO 14024.



SCS INDOOR ADVANTAGE

We pursue industry-independent, third-party testing and indoor air quality certification for many of our products and materials through the Scientific Certification Systems' Indoor Advantage™ program:

- provides credits toward the U.S. Green Building Council's LEED certification
- demonstrates compliance to ANSI/BIFMA criteria for low-emitting furniture
- Indoor Advantage Gold certification also demonstrates compliance to California 01350, ASHRAE 189.1, and CHPS Collaborative for High Performance Schools Criteria for furniture.



E0 AND E1

E1 and E0 are European formaldehyde emission standards. Both E1 and E0 low formaldehyde emissions boards are available in Steelcase to support our clients' environmental requirements.



PRODUCT ENVIRONMENTAL PROFILE (PEP)

Product Environmental Profile (PEP) is a voluntary type II Ecolabel certified according to ISO 14021.

CHINA

- I. Work Points
- II. Meeting Spaces
- III. Work Support Space
- IV. Support Spaces
- V. Task & Visitor Seating

Work Points

- L-Shaped Workstation
- Bench Workstation
- Temporary Workstation
- Manager Office
- Quiet Room
- VIP Section



I. Work Points

L-Shape Workstation



LOW PRICE
Lexicon – Post Legs



MID PRICE
Lexicon – A Legs

How to classify selection

Each L shape workstation configuration shown above is divided into:

- **LOW** – most cost effective
- **MID** – above average to low

The rant criteria is driven by:

- Cost
- Key Features
- Manufacturing Origin
- Design Origin



I. WORK POINTS

CHINA | L SHAPE WORKSTATION L1600 | **LOW PRICE RANGE – LEXICON (POST LEG)**



Image for visual purpose only
 Price is quoted for 1 unit only.

Laminate Desk & Table



Fabric for Workstation Screen – Omni-R Fabric Covered Panel Skins, Bench Centered Screen & Side Screen

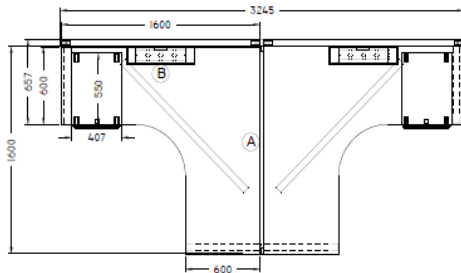


Paint All Tables



Note: Price exclusive of mobile pedestal.

PLAN VIEW



ABOUT THE SOLUTION

- Lexicon Corner Workstation 600D/600D 1600W/1600W
- Lexicon Panel 1150H 1600W 50T
- UPV Mobile Pedestal 1Pencil1Box 1File 407W 550D 646H
- Post Legs

Product Environmental Certifications Model Number:



- L31216FNTFNT
- L5121HNTHT
- L3J12X3535
- L3J12T353
- L5JSSH
- L3J12E
- LW16166060CR
- LW16166060CL
- LWKSPT14RC
- LU055CT
- LWLSPNF
- LWLSPMID

Design Origin: Asia Pacific

LEADTIME: 6 – 8 weeks

Manufacturing Location: ,Dongguan, China



I. WORK POINTS

CHINA | L SHAPE WORKSTATION L1600 | MID PRICE RANGE – LEXICON (A LEG)



Image for visual purpose only
 Price is quoted for 1 unit only.

Laminate
 Desk & Table



Fabric for Workstation Screen – Omni-R
 Fabric Covered Panel Skins, Bench Centered Screen & Side Screen

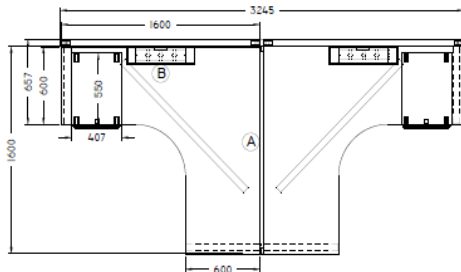


Paint
 All Tables



Note: Price exclusive of mobile pedestal.

PLAN VIEW



ABOUT THE SOLUTION

- Lexicon Corner Workstation 600D/600D 1600W/1600W
- Lexicon Panel 1150H 1600W 50T
- UPV Mobile Pedestal 1Pencil1Box 1File 407W 550D 646H
- Standard A Legs

Product Environmental Certifications Model Number:



- LW16166060CR
- LWKSPT14RC
- LWLSP60
- L3J12E
- L5J12E
- L3J12T535
- L31216FNTFNT
- L51216HNTHTNT
- LU55CTU
- LU55CTHUB
- UPVMPPBF407

Design Origin: Asia Pacific

LEADTIME: 6 – 8 weeks

Manufacturing Location: ,Dongguan, China

Lexicon Desk

Total Workplace System



Lexicon systems enable the shaping of spaces with the ideal balance between privacy for task work and visual connection for collaborative teamwork. A range of layouts, integrated cable management, and worktools enable the personalization and organization of individual tools, resources, and personal items in the workspace to support the task at hand and the way you like to work.

WHY CHOOSE LEXICON?

Lexicon makes it easy to create a variety of workplace applications for both individual and collaborative work with simple solutions for every requirement from benches to desks to panel configurations and tables. All of these use the same components and elements.

KEY FEATURES

- Lexicon systems enable the shaping of spaces with the ideal balance between privacy for task work and visual connection for collaborative teamwork
- Lexicon answers your organization's ability to meet the changing needs of individuals and teams. Lexicon provides the core infrastructure for shaping workspace, defining privacy and connection, and optimizing productivity.

TYPE OF CONFIGURATION

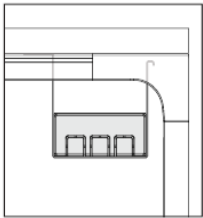
- Benching
- Panel System
- 120 Degree



Lexicon Table - Features

Lexicon makes it easy to create a variety of workplace applications for both individual and collaborative work with simple solutions for every requirement.

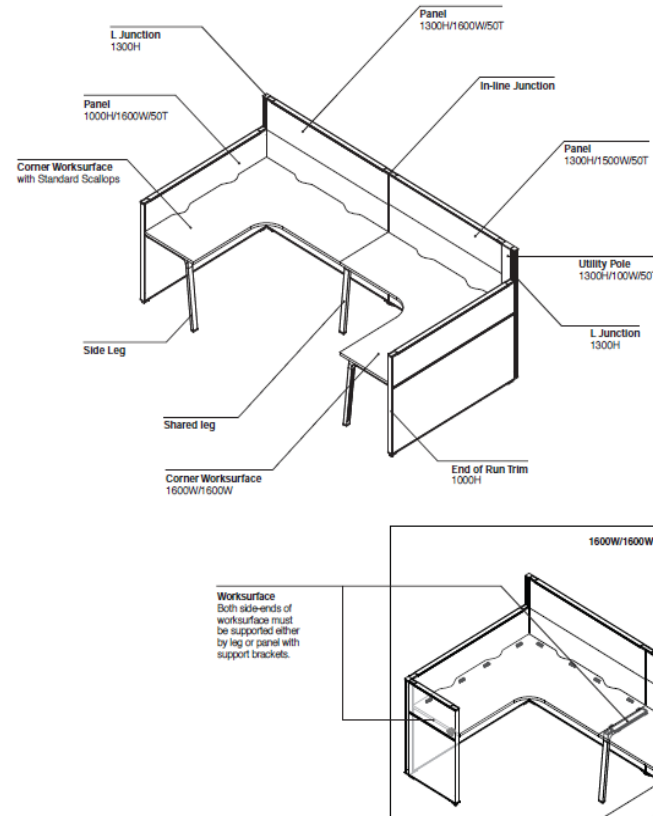
Product Details



The hardwired utility package (box) are made of aluminum trim and two plastic caps at both ends.

1. The utility box are screwed to the cable tray with screws from bottom.
2. Plastic end cap have pre-cut hole for the installer to access data cable, conduits or power cable.
3. The utility box can cater socket box up to 50mm height
4. Under worksurface center mounted keyboard tray cannot be installed on bench
5. Accessory rail, acrylic screen, marker board screen, modesty panel, side modesty panel and vertical cable cover are not standard included items for the desk

Panel System



Sustainability

Designing for sustainability

We believe the only way to provide the best office furniture solutions is to ensure they're the best products for the environment. That's why every step of the way – through design, manufacturing, delivery and product lifecycle – we consider the impact of our work on people and on the environment and uncover opportunities to make things better.

Certifications

Certifications can help you choose products that are environmentally sustainable and just right for your project. Lexicon has achieved the following certifications:

Lexicon desks

- SCS Indoor Advantage certified for indoor air quality
- China Environmental Labeling Product Certification

Lexicon panel

- ANSI/BIFMA X5.6
- AFRDI Green Tick Product Certification
- SCS Indoor Advantage Gold certified for indoor air quality
- China Environmental Labeling Product Certification

Product Data

Additional Product Information:

<http://www.steelcase.com/asia-en/products/desks/lexicon/>



I. Work Points

Bench Workstation



LOW PRICE
Lexicon



MID PRICE
FrameOne

Temporary Workstation



LOW PRICE
Lexicon



MID PRICE
FrameOne

How to classify selection

Each Workstation configuration shown above is divided into 3 rank:

- **LOW** – most cost effective
- **MID**– above average to low

The rank criteria is driven by:

- Cost
- Key Features
- Manufacturing Origin
- Design Origin



I. WORK POINTS

CHINA | BENCH WORKSTATION | LOW PRICE RANGE - LEXICON



Image for visual purpose only
 Price is quoted for 1 unit only.

Laminate Desk & Table



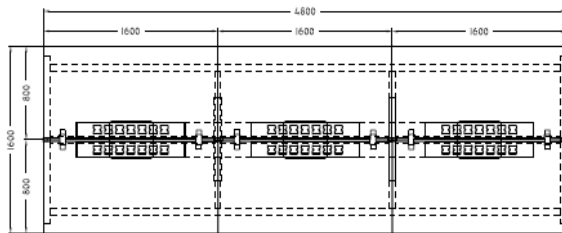
Fabric for Workstation Screen – Omni-R Fabric Covered Panel Skins, Bench Centered Screen & Side Screen



Paint All Tables



PLAN VIEW



ABOUT THE SOLUTION

- Lexicon Freestanding Bench 4800W 1600D 720H
- Lexicon Fabric Centre Screen 285H
- With Flip Up Tray.

Product Environmental Certifications Model Number:



- LBFD3A4816LF
- LBUDAVCC
- LBUD10CTHUP
- L3SBC28160TB
- L3SJ28E
- L3SJSSH

Design Origin: Asia Pacific

LEADTIME: 6 – 8 weeks

Manufacturing Location: Dongguan, China

Lexicon Bench

Total Workplace System



Lexicon systems enable the shaping of spaces with the ideal balance between privacy for task work and visual connection for collaborative teamwork. A range of layouts, integrated cable management, and worktools enable the personalization and organization of individual tools, resources, and personal items in the workspace to support the task at hand and the way you like to work.

WHY CHOOSE LEXICON?

Lexicon makes it easy to create a variety of workplace applications for both individual and collaborative work with simple solutions for every requirement from benches to desks to panel configurations and tables. All of these use the same components and elements.

KEY FEATURES

- Lexicon systems enable the shaping of spaces with the ideal balance between privacy for task work and visual connection for collaborative teamwork
- Lexicon answers your organization's ability to meet the changing needs of individuals and teams. Lexicon provides the core infrastructure for shaping workspace, defining privacy and connection, and optimizing productivity.

TYPE OF CONFIGURATION

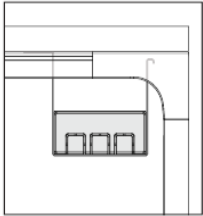
- Benching
- Panel System
- 120 Degree



Lexicon Table - Features

Lexicon makes it easy to create a variety of workplace applications for both individual and collaborative work with simple solutions for every requirement.

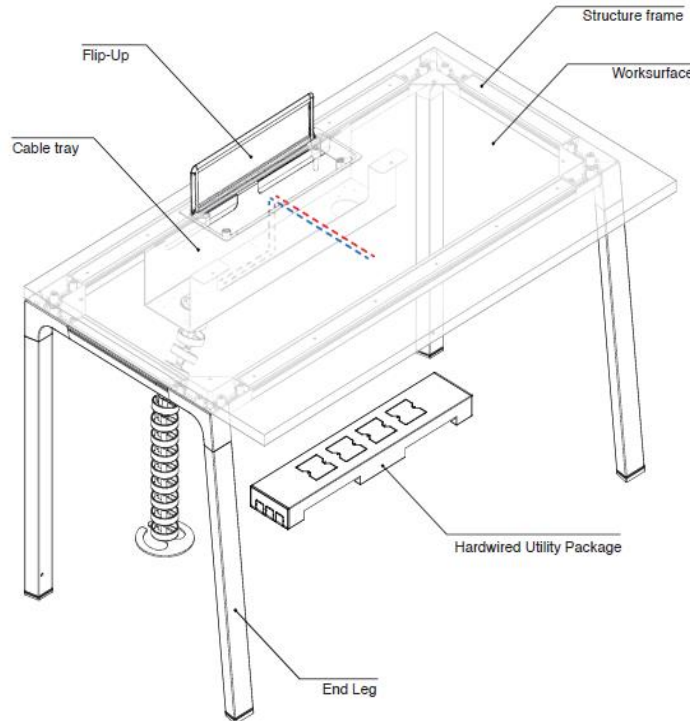
Product Details



The hardwired utility package (box) are made of aluminum trim and two plastic caps at both ends.

1. The utility box are screwed to the cable tray with screws from bottom.
2. Plastic end cap have pre-cut hole for the installer to access data cable, conduits or power cable.
3. The utility box can cater socket box up to 50mm height
4. Under worksurface center mounted keyboard tray cannot be installed on bench
5. Accessory rail, acrylic screen, marker board screen, modesty panel, side modesty panel and vertical cable cover are not standard included items for the desk

Freestanding Desk of Lexicon



Sustainability

Designing for sustainability

We believe the only way to provide the best office furniture solutions is to ensure they're the best products for the environment. That's why every step of the way – through design, manufacturing, delivery and product lifecycle – we consider the impact of our work on people and on the environment and uncover opportunities to make things better.

Certifications

Certifications can help you choose products that are environmentally sustainable and just right for your project. Lexicon has achieved the following certifications:

Lexicon desks

- SCS Indoor Advantage certified for indoor air quality
- China Environmental Labeling Product Certification

Lexicon panel

- ANSI/BIFMA X5.6
- AFRDI Green Tick Product Certification
- SCS Indoor Advantage Gold certified for indoor air quality
- China Environmental Labeling Product Certification

Product Data

Additional Product Information:

<http://www.steelcase.com/asia-en/products/desks/lexicon/>



I. WORK POINTS

CHINA | BENCH WORKSTATION | MID PRICE RANGE - FRAMEONE



Image for visual purpose only
 Price is quoted for 1 unit only.

Laminate

Desk & Table



Fabric for Workstation Screen – Omni-R

Fabric Covered Panel Skins, Bench Centered Screen & Side Screen

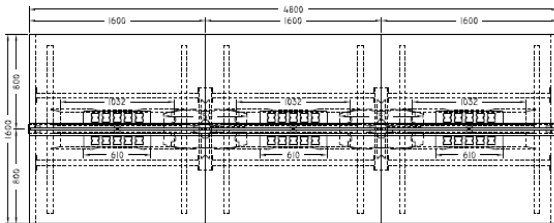


Paint

All Tables



PLAN VIEW



ABOUT THE SOLUTION

- FrameOne Enhanced Dual Bench 1600W 800D
- Center Screen Fabric 1600W 435H

Product Environmental Certifications Model Number:



- FMED1616
- FMBD1616
- FMAL
- FMSCF0416
- FMMLCD

Design Origin: Europe

LEADTIME: 6 – 8 weeks

Manufacturing Location: Dongguan, China

FrameOne Bench

Total Workplace System



FrameOne benching workstations are designed to enrich varying levels of mobility and collaboration required by workers and workplaces today, offering more customizable options than other bench applications.

WHY CHOOSE FRAMEONE?

The light elegant lines of the modular steel structure support the shaping of space to meet the changing needs of organizations, teams and individuals. A simple menu of components and elements, together with the easy integration of Steelcase worktools enables the customizing of workspaces to support individual ways of working, while creating space-efficient working environments.

KEY FEATURES

- Tailor to every worker's needs
- The traditional, one-size-fits-all bench desks are ineffective for both workers and organizations.
- FrameOne offers more customizable options than other bench desk applications, and its modular design adapts easily to maximize real estate and adjust to changing business needs.
- A light, refined aesthetic
- Floating tops
- Recessed legs



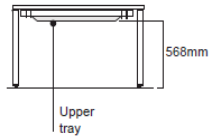
FrameOne - Features

FrameOne benching workstations are designed to enrich varying levels of mobility and collaboration required by workers and workplaces today, offering more customizable options than other bench applications.

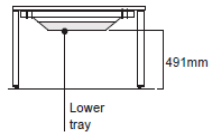
Product Details

FrameOne Bench

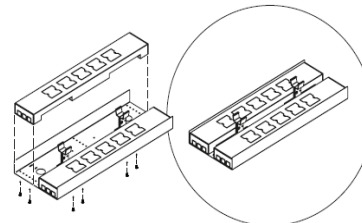
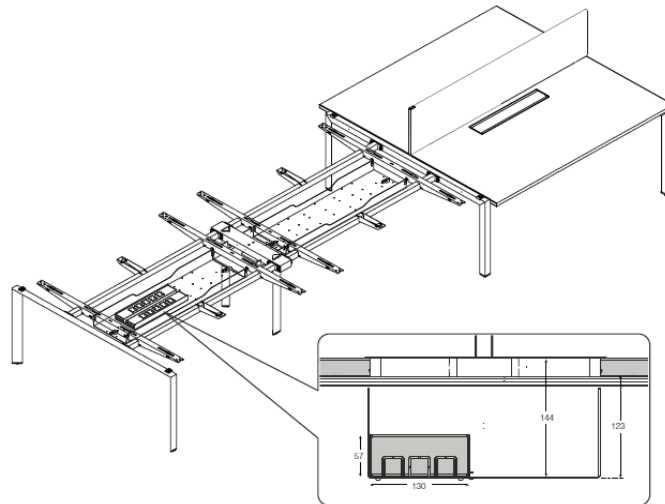
Trays are available on dual-sided base and extension units. There are two tray options.



Upper tray is optional and provides under the surface cord management, data termination, and conceals the power blocks and conduit.



The lower tray is optional and always used in conjunction with an upper tray. It is intended for use when voice/data cables are being routed. It conceals data cables creating a clean visual.



Lexicon Hardwired Utility Package can be used for hardwiring solution.

Sustainability

Designing for sustainability

We believe the only way to provide the best office furniture solutions is to ensure they're the best products for the environment. That's why every step of the way – through design, manufacturing, delivery and product lifecycle – we consider the impact of our work on people and on the environment and uncover opportunities to make things better.

Certifications

Certifications can help you choose products that are environmentally sustainable and just right for your project. FrameOne has achieved the following certifications:

SCS Indoor Air Advantage Certified

- SCS IAQ Gold
- SCS IAQ (private office only)

Product Data

Additional Product Information:

<http://www.steelcase.com/asia-en/products/benching/frameone/>



I. WORK POINTS

CHINA | TEMPORARY WORKSTATION | LOW PRICE RANGE - LEXICON



Image for visual purpose only
 Price is quoted for 1 unit only.

Laminate
 Desk & Table



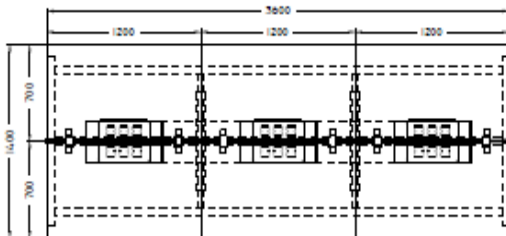
Fabric for Workstation Screen – Omni-R
 Fabric Covered Panel Skins, Bench Centered Screen & Side Screen



Paint
 All Tables



PLAN VIEW



ABOUT THE SOLUTION

- Lexicon Freestanding Bench 3600W 1400D 720H
- Lexicon Fabric Centre Screen 285H

Product Environmental Certifications Model Number:



- LBFD3A3614LF
- LBUDAVCC
- LBUD06CTHUP
- L3SBC28120TB
- L3SJ28E
- L3SJSSH

Design Origin: Asia Pacific

LEADTIME: 6 – 8 weeks

Manufacturing Location: Dongguan, China



I. WORK POINTS

CHINA | TEMPORARY WORKSTATION | MID PRICE RANGE – FRAMEONE



Image for visual purpose only
 Price is quoted for 1 unit only.

Laminate

Desk & Table



Fabric for Workstation Screen – Omni-R

Fabric Covered Panel Skins, Bench Centered Screen & Side Screen

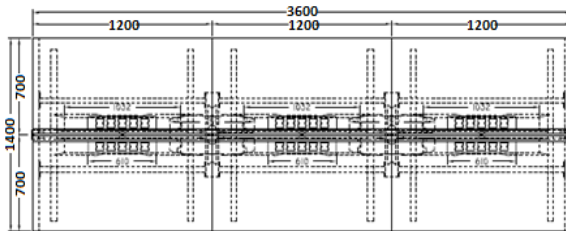


Paint

All Tables



PLAN VIEW



ABOUT THE SOLUTION

- FrameOne Enhanced Bench 3600W 1400D 720H
- Lexicon Fabric Centre Screen 285H

Product Environmental Certifications Model Number:



- FMED1412
- FMBD1412
- FMSCF0412
- FMAL
- FMMLCD

Design Origin: Europe

LEADTIME: 6 – 8 weeks

Manufacturing Location: Dongguan, China



I. Work Points

Manager Office



LOW PRICE
Lexicon Settings



MID PRICE
Impact Executive

Quiet Room



Lexicon Desk

How to classify selection

Each Manager Office configuration shown above is divided into:

- **LOW**—most cost effective
- **MID** - above average to low

Quiet Room, - only with 1 option based on Huawei Playbook requirements.

The office rank criteria is driven by:

- Cost
- Key Features
- Finishes
- Design Origin



I. WORK POINTS

CHINA | MANAGER OFFICE | LOW PRICE RANGE – LEXICON DESK + UPV STORAGE



Image for visual purpose only

Laminate
 Desk & Table



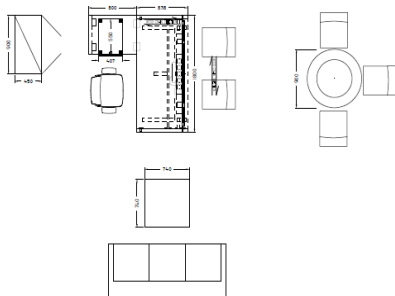
Fabric for Workstation Screen – Omni-R
 Fabric Covered Panel Skins, Bench Centered Screen & Side Screen



Paint
 All Tables



PLAN VIEW



IEW 1:25 ON A3

ABOUT THE SOLUTION

- Lexicon Single sided desk 1800W 800D - Standard A Legs
- Return desk 800W 600D
- UPV storage Hinged Door 4HB
- UPV Mobile Pedestal 1Pencil1Box 1File 407W 550D 646H
- Lexicon Round Table 900D 720H
- Cittern Coffee Table Square 740W 740D 400H
- Cittern Sofa 3-Seater 1930W 830D 850H
- Think Task 3D knit
- Think Sled base Armless

Model Number:

- LW16166060CR
- LWKSPT14RC
- LWLSPP60
- L3J12E
- L5J12E
- L3J12T535
- L31216FNTFNT
- L51216HNTHTNT
- LU55CTU
- LU55CTHUB
- UPVMPPBF407

Product Environmental Certifications



Design Origin: America and Asia Pacific

LEADTIME: 6 – 8 weeks

Manufacturing Location: Dongguan, China

Lexicon Desk

Support of Management Styles



VERSATILE SUPPORT FOR DIVERSE MANAGEMENT STYLES

Lexicon standalone units enable the creation of workspaces to support different management styles, whether open management for easy interaction with team members and workers, to spaces that provide visual and acoustic privacy for confidential work. Standalone units enable the shaping and reshaping of space to meet changing needs, such as workstations for individual work and one-on-one meetings, and small tables for close collaboration and sharing.

GET PERSONAL WITH WORKTOOLS

Tailor Lexicon to the needs of individual workers and the work at hand with adjustable privacy components, flexible storage, versatile computer support and an innovative collection of worktools.



SOTO II Mobile Caddy
anticipates the need to stow personal items and work bags. In-line casters make it easy to roll out to drop in bags or backpacks, as well as creating a sense of boundary.



SOTO LED Task Lights
a stylish blend of elegant form with energy-efficient function, the illuminating performance provides a brilliant pool of light for focused task work whenever it is required.



AP CPU Holder
provides a quick and smart solution for securely storing the CPU under the worktop, opening up valuable space on the worktop and floor while ensuring easy access to the CPU.



I. WORK POINTS

CHINA | MANAGER OFFICE | MID PRICE RANGE – IMPACT DESK

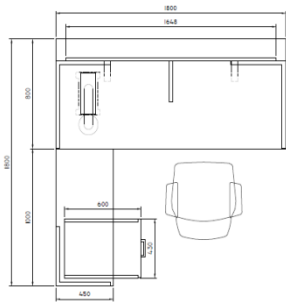


Image for visual purpose only

Wood veneer



PLAN VIEW



ABOUT THE SOLUTION

- IMPACT - Executive Collection (Veneer) - 1800W 800D 730H
- End Panel Support
- L-Return Square edge – 450D 1000W 730H
- Modesty Panel 1800W 520H
- Vertical cable riser
- Hinged door tower storage – 450D 900W 1800H
- Convene round table top with X-panel Base – 900DIA 730H
- Convene lounge rectangular table – 500D 1000W 410H

Design Origin: America

- Think Task 3D knit
- Think Sled base Armless
- Alto Three-Seater Sofa

Product Environmental Certifications



LEADTIME: 6 – 8 weeks

Manufacturing Location: Dongguan, China

Model Number:

- INWS1880ST
- INES1045/LB
- INL30KP
- INA1852MP
- INL66EL
- INL66ER
- INF4360BBFM
- INCMGTNP
- INF9045DD
- CWK09RD
- CWL61XS
- C48006-CWK1050ST



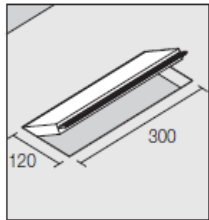
IMPACT
EXECUTIVE COLLECTION PRODUCT

Product Information Packet

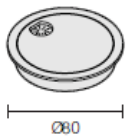
Impact - Features

EXECUTIVE

Product Details

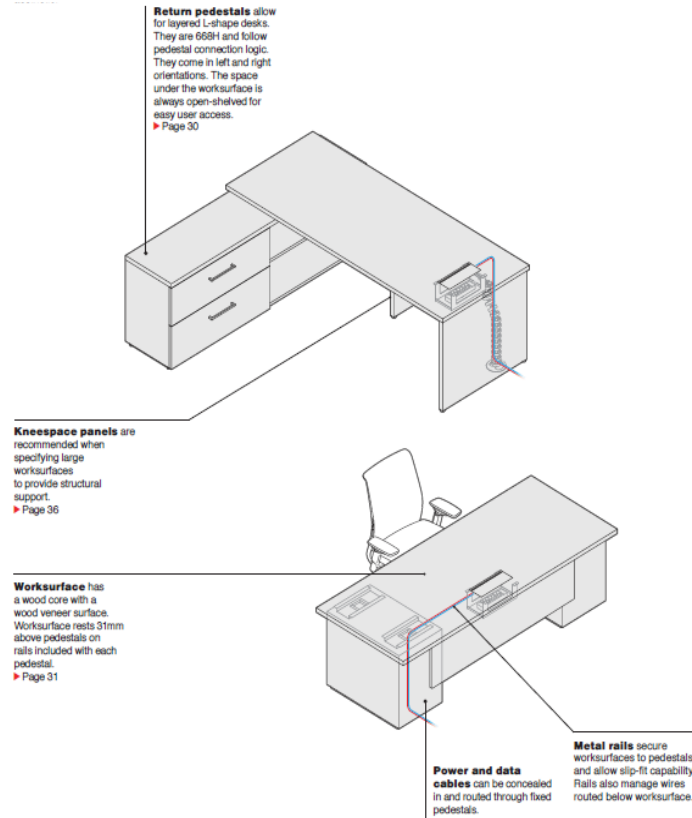


Flippers are flushed with worksurface and are finished in the same veneer as the worksurface. This option provides easy access to power and data from the worksurface, ideal for frequent user access.



Round grommets can be specified for routing cables that would not need to be accessed as often, and are for more long term installations. Ideal for lighting, netboxes and monitors.

Impact Executive



Impact is a flexible, and distinctive system that offers functionality and an exceptionally refined aesthetic bringing clean, modern design to any executive workspace.

Why choose Impact?

SPACE THAT DOES MORE

Impact was designed for the needs of the modern day high-performance executives to enable a space that works harder and smarter.

SMART SUPPORT FOR THE EXECUTIVE

Impact is offered in a wide variety of table bases, supports and worksurfaces, allowing it to be configured in numerous ways to fit any room. The desks provide integrated power managements attributing to its clean aesthetics.

INTEGRATED PREMIUM STORAGE

Impact's storage is offered in various heights, towers, pedestals and overhead wall-mounts. The various elements provide the flexibility to create grand storage walls or sleek, layered applications.

QUALITY IN EVERY DETAIL

Quality craftsmanship is evident in the refined finish and attention to details. The elegance of the edge profiles, smooth integration of technology and stylish design complete the creation of an understated, high-performance working environment.

Key Features

- Comprehensive Desking And Storage System
- Creating Quiet Spaces For Focused Work
- Private Offices That Optimize Real Estate



I. WORK POINTS

CHINA | QUIET ROOM | LEXICON DESK



Image for visual purpose only
 Chairs are not included in the price.

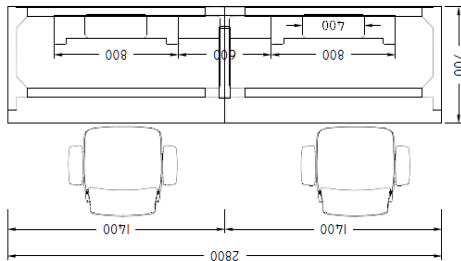
Laminate Desk & Table



Paint All Tables



PLAN VIEW



ABOUT THE SOLUTION

- Lexicon Desk
- Single Sided Bench 700D 2800W 2 units, 720H
- Structure and Legs
- Vertical Cable Cover for 700D Straight Bench
- Power is not included.

Product Environmental Certifications Model Number:



LBUSVCC70

Design Origin: Asia Pacific

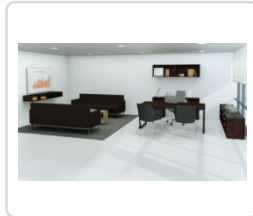
LEADTIME: 6 – 8 weeks

Manufacturing Location: Dongguan, China



I. Work Points

VIP Room



PRIVATE OFFICE
FrameOne Enhanced +
Impact Furniture



RECEPTION
SW_1 Chair + Table



MEETING ROOM
Convvene Table



HUDDLE SPACE
4.8 Meeting Table



COLLABORATION SPACE
Campfire Big Table + Think
Stool



BENCHING
Sit2Stand Height Adjustable



TASK CHAIR
Gesture

How to classify selection

Each VIP configuration shown above is divided into different settings in the room:

- PRIVATE OFFICE
- RECEPTION
- MEETING ROOM
- HUDDLE SPACE
- COLLABORATION SPACE
- BENCHING
- TASK CHAIR



I. WORK POINTS

CHINA | VIP ROOM | PRIVATE OFFICE – FRAMEONE DESK + IMPACT STORAGE



Paint
 All Tables

White 7341 Silver 82

Leather - Gesture
 M351 Black

Veneer (Standard Veneer)

Maple (Composite) Clear Oak (Composite) Natural Walnut (Composite) Natural Walnut (Flat Cut) Dark Brown on Walnut (Composite) Dark Brown on Walnut (Flat Cut) Rosewood on Oak (Composite) Dark Mahogany on Walnut (Flat Cut) Teak (Composite) Medium Walnut (Composite) Cherry on Walnut (Flat Cut)

Veneer (Premium Veneer)

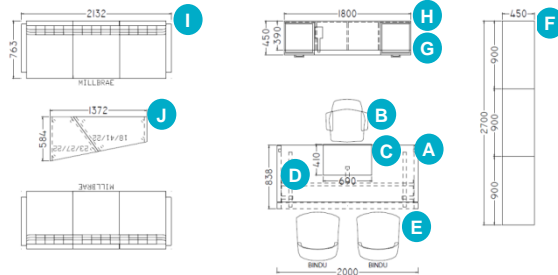
Clear Walnut (Flat Cut) Graphite Walnut (Flat Cut) Espresso Oak (Quarter Cut) Clear Bamboo

Leather – Milbrae Sofa

GR0E	GRADE E LEATHER SELECTION	
L318	ER LDAM DR5127	
L319	ER EBONY DR5191	
L321	ER BEIGE DR5179	
L323	ER BUFF DR5195	
L325	ER CAMEL DR5136	
L326	ER CHARBROWN DR5187	
L330	ER FLAME DR5163	
L332	ER HONEY DR5132	
L334	ER MIST GREEN DR5153	
L337	ER RUSSET DR5194	

GR0E	GRADE E LEATHER SELECTION	
L338	ER RUST DR5186	
L363	ER TENDRIL	
L364	ER FOG	
L365	ER SUNFLOWER	
L366	ER TERRA COTTA	
L367	ER CADET	
L368	ER MARINE	
L369	ER MALLARD	
L370	ER SMOKE	

PLAN VIEW



ABOUT THE SOLUTION

- A. FrameOne Desk – Veneer (800D 2000W)
- B. Gesture shell back – Leather
- C. Desk Pad
- D. LED Light
- E. Bindu Visitor Chair – Leather
- F. Millbrae Three-seater sofa
- G. Sebastopol Small and Large Table
- H. Impact Overhead – Wall Mounted Cabinet (390D 1800W 445H)
- I. Impact – Credenza with 2 pedestal
- J. Impact Credenza with drawers and shelf

Design Origin: America & Europe

Product Environmental Certifications Model Number:



FMB58020
 WTDSDP
 INCT1845/2N2
 INWM1844S
 INCL9045/UD
 WTDSLEDF1
 442A30
 CO300
 COEB2723H
 COEB4118H
 COMFLA3

LEADTIME: 6 – 12 weeks

Manufacturing Location: Puchong, Malaysia; Dongguan, China; Americas



MILLBRAE CONTRACT
LOUNGE CHAIR

Product Information Packet

RESPONSE TO:

Huawei Technologies - Global

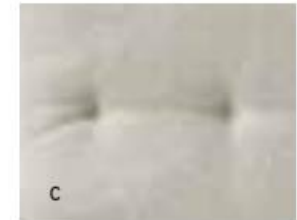
Request for Proposal

Millbrae Contract - Features

Drawing from the refinement of mid-century designs, Millbrae Contract Lounge and Millbrae Lifestyle Lounge by Coalesse enhance the social atmosphere of contemporary workplaces.

Millbrae instills a social feeling perfect for today's progressive workplaces. The modern foundation supports classic tufted upholstery and is available in either the Lifestyle Lounge or Contract Lounge style to furnish lobbies or lounge areas.

- One-, two-, three-, or four-seat lounge
- Arm, armless, and single-arm options
- One-, two-, three-, or four-seat bench
- Brushed nickel or gloss black base
- Coordinating bolsters available
- level™ 1 certified



Product Features

Millbrae Lifestyle

- One, two or three seat lounge
- Soft comfort, arm detail (A) and back detail (B)
- Cross hatch stitch (C)

Millbrae Contract

- One, two, three or four seat lounge with or without armrest (D) (one arm only possible on one seat)
- One, two, three or four seat soft bench (H)
- Tufted pattern accents (E)
- Firm comfort

Millbrae Contract And Lifestyle

- Gloss black painted base (F) or brushed nickel (G) as an option
- Coordinating round or square bolster available (attached to the lounge as an option) (I)
- Optional ganging bracket to join Millbrae Contract elements together in order to create various configurations
- Available in a wide range of fabrics and leather





BINDU
Modern Chair

Product Information Packet




















Bindu Modern Chair - Features

Modern classic. Classic conference seating that balances comfort and performance. Bindu is work's new feel.

Modern side or guest seating sensibly designed to express a softer, more residential feeling with contract durability. Bindu Chair combines the comfort and craft of an upholstered lounge with the performance needs of a work task chair. Work's new feel, expressed in a modern classic.

- Mid-back and low-back options
- Trivalent chrome or black gloss painted 4-leg base
- SCS Indoor Advantage™ Gold Certified
- 50% Recyclable / 11% Recycled Content

Leather - Bindu

GR0E	GRADE E LEATHER SELECTION	
L318	ER LOAM DR5127	
L319	ER EBONY DR5191	
L321	ER BEIGE DR5179	
L323	ER BUFF DR5195	
L325	ER CAMEL DR5136	
L326	ER CHARBROWN DR5187	
L330	ER FLAME DR5163	
L332	ER HONEY DR5132	
L334	ER MIST GREEN DR5153	
L337	ER RUSSET DR5194	
L338	ER RUST DR5186	
L363	ER TENDRIL	
L364	ER FOG	
L365	ER SUNFLOWER	
L366	ER TERRA COTTA	
L367	ER CADET	
L368	ER MARINE	
L369	ER MALLARD	
L370	ER SMOKE	

Product Features

- Detail of arm and flexing back (A)
- Headrest detail (B)
- Adjustable height and tilt lever detail (C)
- Arm detail (D)
- Dual wheel hard caster in black resin (E)
- Non-marking polymer glide for guest seating (F)
- Bases available in black (G) or polished aluminum (H)





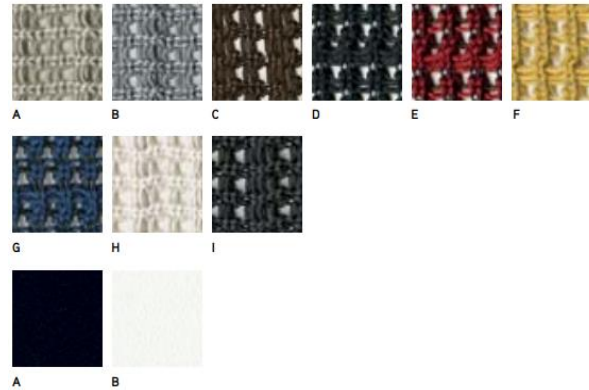
I. WORK POINTS

CHINA | VIP ROOM | RECEPTION AREA – SW_1 LOUNGE CHAIR + TABLE



Image for visual purpose only

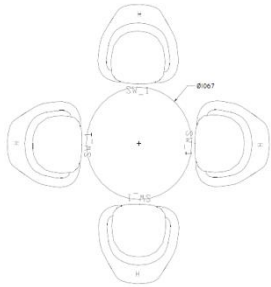
Surface Materials



- 3D Knit Mesh**
 A. 5K20 Stone
 B. 5K21 Gray
 C. 5K23 Brown
 D. 5K24 Black
 E. 5K25 Garnet
 F. 5K26 Golden
 G. 5K27 Royal
 H. 5K28 Ivory
 I. 5K29 Coal

- Tablet Colors**
 A. 6000 Black
 B. 6052 Milk

PLAN VIEW



ABOUT THE SOLUTION

- SW_1 Lounge Chair - High back, 4 star, glides
- SW_1 Table - Laminate, 42w x 15h

Product Environmental Certifications



Model Number:

COWLRND42
 COW712

Design Origin: America

LEADTIME: 6 – 8 weeks

Manufacturing Location: Americas



SW_1 LOUNGE
LOUNGE & MEETING TABLE

Product Information Packet

SW_1 - Features

LOUNGE SETTING

SW_1® collection is a fitting solution for the new realities of workplace collaboration. Lower and more intimate. Wider and more comfortable. Lounge-inspired yet task-oriented. The backs breathe. The bases swivel. The tablets come to you. SW_1 is an eloquent rethink of the meeting room. A whole new system of collaborative possibilities.

Why choose SW_1?

SW_1 moves effortlessly from the conference room to public spaces and training rooms for a wide range of collaborative options.

Key Features

- Tables are available in four shapes and a range of sizes
- Optional grommet and cable management are available to host technology
- Tables are offered in a wide range of finishes including veneers, glass and solid white surface
- Chairs offer two swiveling base options
- Mesh backs add breathability
- Cushions can be re-upholstered
- Chairs offered in Conference (28.5") and Collaborative (26") heights
- Chairs work well with a desk, as a side chair or at a conference table

Certifications

Certifications can help you choose products that are environmentally sustainable and just right for your project. Turnstone Campfire has achieved the following certifications:

- ANSI/BIFMA e3-2014e – level® 1
- SCS-IAQ-01820 – Lounge Seating

Product Data

Additional Product Information:

http://www.coalesse.com/collections/sw_1-collection/





I. WORK POINTS

CHINA | VIP ROOM | MEETING TABLE – CONVENE MEETING TABLE + THINK CHAIR

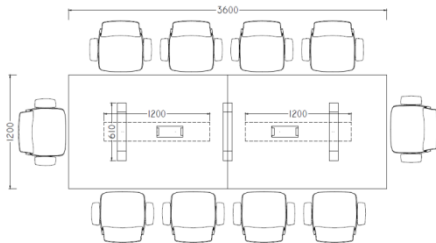


Image for visual purpose only

Wood veneer



PLAN VIEW



ABOUT THE SOLUTION

- Convene Meeting Table
- 3600W x 1200D
- Think Task Chair

Product Environmental Certifications



Model Number:

CWK3612ST
 INA12CT
 CWL61US
 465A000

Design Origin: America

LEADTIME: 6 – 8 weeks

Manufacturing Location: Dongguan, China

Convene Table - Features

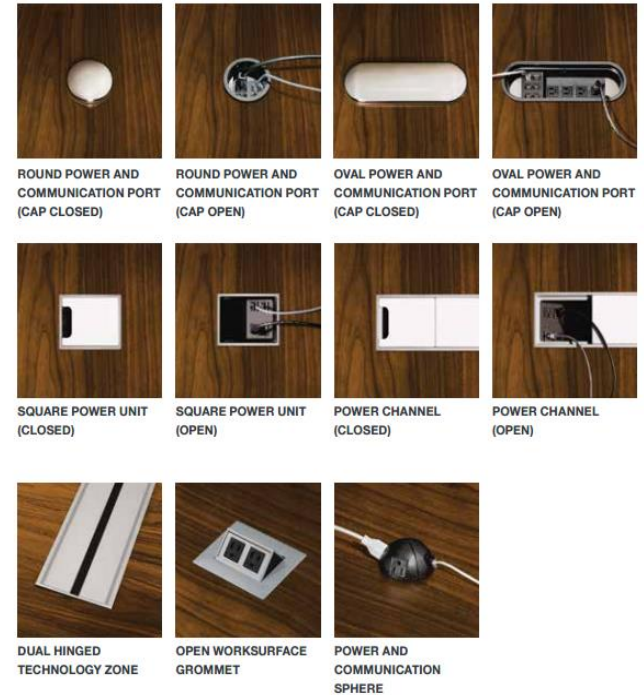
MEETING TABLE

MAKE AN ELEGANT STATEMENT IN THE BOARDROOM

The Convene range provides stylish conferencing solutions for the executive boardroom, conference rooms and meeting spaces. The elegance of the wide range of table shapes and sizes is complemented by the low-profile storage elements and integrated management of power and data wiring.



INTEGRATED OPTIONS.





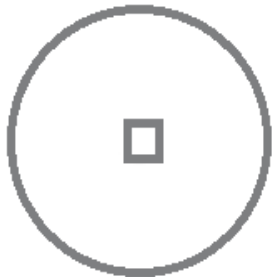
I. WORK POINTS

CHINA | VIP ROOM | HUDDLE SPACE – 4.8 TABLE + THINK SLED CHAIR



Image for visual purpose only

PLAN VIEW



ABOUT THE SOLUTION

- 4.8 Meeting Table (Round) - Veneer
- 1250Diameter
- Laminate top options is available with lower cost.
- Think Sled

Product Environmental Certifications



Model Number:

48ST125D1CVC
 48SSRDSSW
 48AMCTRDSSP
 465D000

Design Origin: Europe

LEADTIME: 6 – 8 weeks

Manufacturing Location: Dongguan, China



FOUR POINT EIGHT TABLE (4.8) CONFERENCE & MEETING TABLE

Product Information Packet

4.8 Table - Features

MEETING TABLE

The 4.8 four point eight meeting table integrates technology with an innovative “plug ‘n play” connectivity that is integrated into the centre of the table, enabling the work surface to be clutter-free.

Why choose 4.8?

SMART INTEGRATION OF TECHNOLOGY

Power, data connectivity and cabling for almost any device is integrated into the center of the table, all neatly kept below sliding covers to ensure a clutter-free work surface.

By attaching bridges to the central cable tray, additional tools and other accessories can be added for extra space, organization and personalization.

PERFECT COMFORT WHEREVER YOU SIT

The light, open aluminum structure and central beam minimize the number of table legs required for support and optimize user comfort. Only 4 legs are required for a width of 3240mm.

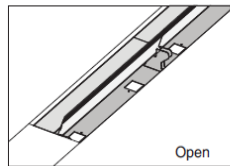
SPACE EFFICIENCY

4.8 four point eight is available in a variety of dimensions and can adapt to suit any environment.

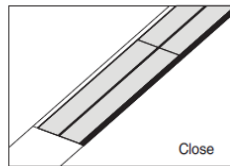
PRODUCT FEATURES

The 4.8 four point eight meeting table integrates technology with an innovative “plug ‘n play” connectivity that is integrated into the center of the table, enabling the work surface to be clutter-free.

Cable Tray Package

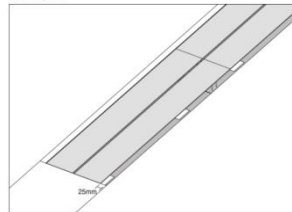


Open



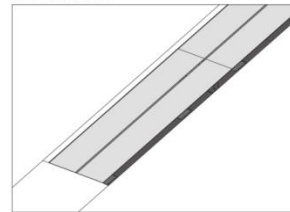
Close

Standard flip cover



25mm

Brush type flip cover (Grey brush)





I. WORK POINTS

CHINA | VIP ROOM | COLLABORATION SPACE – CAMPFIRE BIG TABLE + THINK STOOL CHAIR

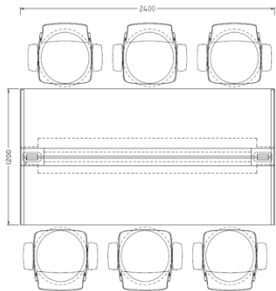


Image for visual purpose only

Laminate
 Desk & Table



PLAN VIEW



ABOUT THE SOLUTION

- Campfire Big Table – Standing Height (40")
- Think Stool - Leather
- Power rail included
- Power can be excluded for lower cost.

Product Environmental Certifications



Model Number:

CF4TLT40
 CF4TPWR
 465B000

Design Origin: America

LEADTIME: 6 – 8 weeks

Manufacturing Location: Dongguan, China

RESPONSE TO:

Huawei Technologies - Global

Request for Proposal

Turnstone Campfire Big Table - Features

TABLE

Big Table was inspired by the way people gather in social and collaborative settings, the center of attraction that naturally draws people together to share, collaborate and create. Its clean simple lines makes it extremely versatile, a great place to get a team together to workshop, or for smaller teams to spread their work out and share information visually.

Why choose Big Table?

CREATE VERSATILE SPACES FOR TEAM WORK

With increasing collaboration time spent in informal and unstructured work, Campfire Big Table provides a focused space and support for effective interaction and productive collaboration. A clear worksurface and easy integration of technology enhance sharing, while a choice of heights supports working while seated – or standing.

Foster Collaboration With Standing Height

Standing height Big Table creates a comfortable height for team interaction and democratic eye-to-eye contact, expanding the available palette of posture and place, and contributing to individual wellbeing.

Support Informal Collaboration

Big Table provides a more space-efficient option than dedicated team project or meeting rooms, defining open team spaces for impromptu meetings through to embedded projects without the commitment and real estate requirements of walled rooms.

Make Social Spaces More Dynamic

Adding the Big Table to coffee areas or lobbies creates high value collaborative and touchdown spaces.

Certifications

Certifications can help you choose products that are environmentally sustainable and just right for your project.

Turnstone Campfire Big Table has achieved the following certifications:

- BIFMA X5.5-2014 Desk/Table Products
- SCS IAQ Gold

Product Data

Additional Product Information:

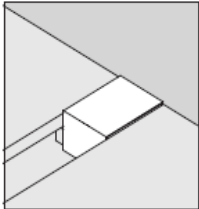
<https://www.steelcase.com/asia-en/products/tables/big-table/>



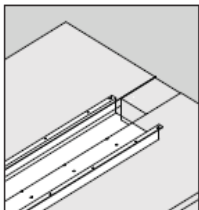
Turnstone Campfire Big Table - Features

Big Table makes it extremely versatile, a great place to get a team together to workshop, or for smaller teams to spread their work out and share information visually.

Product Details

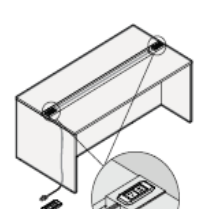


End cover come standard on each end of Big Table with trough when power is not optioned.



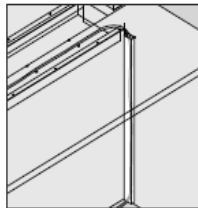
Big Table trough is a silver color painted tray that allows for cable management. Either end of the trough comes standard with a end cover. Trough and trough cover come standard on split worksurface.

Wiring and Cabling



Optional anodized aluminum table rail installs in the table trough and allows for SOTO rail accessories. Can be ordered separately. When ordering center rail, trough covers cannot be selected.

Dual power and USB solutions are available as a standard option with a 2 m cord. CF4TPWR and CF4TUSB requires one building outlet and provides 4 user outlets. When ordering USB, user will get one user outlet and 2 USB on each end.

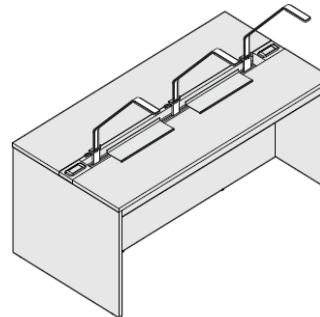
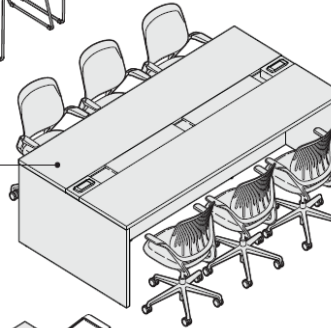
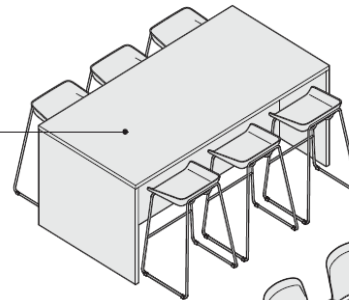


Vertical cord covers come in two heights, 730 and 1030mm. Vertical cord covers are used to route electrical cords vertically on Big Table with trough.

Big Tables are offered in Low- Pressure Laminate. Table tops are 30mm thick.

Big Table is available in seated height 730mm or standing height at 1030mm

Big Tables are available with an uninterrupted worksurface or can be specified with a split worksurface top with a trough that runs down the center of the table. Big tables with a trough also include trough covers that allow for maximisation of space and fosters collaboration.



Personal table is constructed of bent plywood with rift-cut natural oak veneer finish. It nests underneath Big Lounge and can be used as a writing surface for laptops.

Note: The angle is not approved to be used for food or drinks.

Actual Dimensions (mm)

Big Table

Depth	1200
Width	2400
Height	730 or 1030

Footrall

Depth	280
Width	2334
Height	260

Secondary Shelf

Depth	291
Width	2330
Height	80

Trough

Depth	251
Width	2070
Height	82
Opening width	135



I. WORK POINTS

CHINA | VIP AREA | SIT2STAND HEIGHT ADJUSTABLE TABLE



Image for visual purpose only
 Price is quoted for 1 unit only.

Laminate Desk & Table



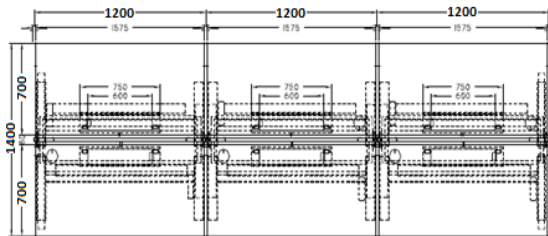
Fabric for Workstation Screen – Omni-R Fabric Covered Panel Skins, Bench Centered Screen & Side Screen



Paint All Tables



PLAN VIEW



ABOUT THE SOLUTION

- Sit2Stand Bench 3600W 1400D 720H
- Lexicon Fabric Centre Screen 285H
- Electric (Motorize)

Design Origin: Europe

Product Environmental Certifications



Model Number:

- S2SWSSD127
- S2SSCSD1200
- S2SCL2PEXT12
- S2SCL2P1200
- L3SJSSH
- S2SL30SJ72E
- S2SLTSD1200
- S2SUT400
- S2SL30SCR7212
- S2SL30SBKTCS
- WTS2SBTUT
- WTS2SFLBT

LEADTIME: 6 – 8 weeks

Manufacturing Location: Puchong, Malaysia

Sit2Stand

Height Adjustable Table



The versatile Sit2Stand provides users with a palette of posture – a variety of options to sit, stand or move throughout their day, with choice and control over how they work.

WHY CHOOSE SIT2STAND?

Whether you're sitting, standing or generally moving around during the day, Sit2Stand's versatile manual or electric adjustment makes a quick switch of posture easy, providing support that will energize and inspire, enhancing your feeling of wellbeing.

KEY FEATURES

Range of Adjustments:

Sit-to-Stand adjustability (from floor to top of worksurface)

Flexible design

The simplicity and sophistication of sit2stand's design fit right in with a wide range of interior design styles. a range of worksurface sizes, shapes and finishes enable the creation of flexible workspaces that meet the changing needs of individuals, teams and organizations.

Worksurface Shape:

Rectangular
Dual Sided Rectangular
90 Degrees Corner
90 Degrees Extended Corner



Supported Configuration

Single Desk or Bench Configuration



Crank Option

Hand
Motorized

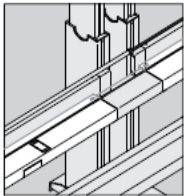
Sit2Stand - Features

The versatile Sit2Stand provides users with a palette of posture – a variety of options to sit, stand or move throughout their day, with choice and control over how they work.

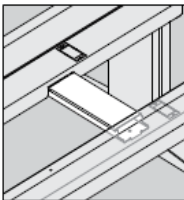
Product Details

High Capacity Lower Tray

High capacity lower tray is used to hold high volume of cables.

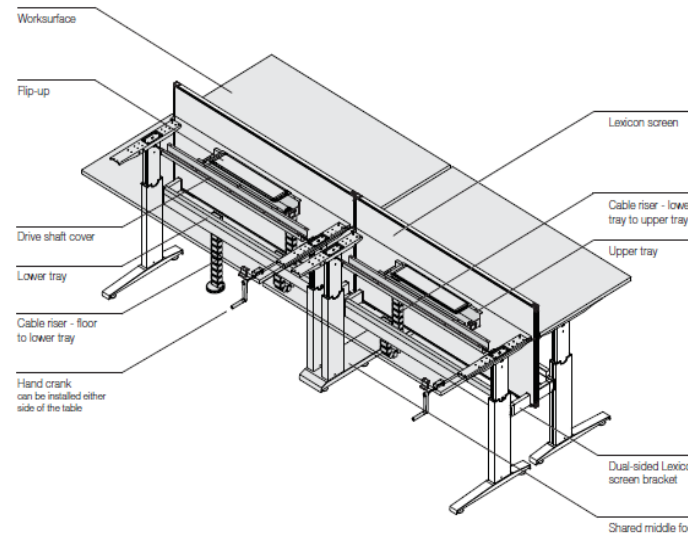


Please note that high capacity lower tray has a capacity to hold twenty-five (25) pieces of 6mm diameter cables and seven (7) pieces of 8mm power cables with a separator.



High capacity lower tray cross over bridge is available to cross over two high capacity lower trays that are facing each other.

FrameOne Bench



Sustainability

Designing for sustainability

We believe the only way to provide the best office furniture solutions is to ensure they're the best products for the environment. That's why every step of the way – through design, manufacturing, delivery and product lifecycle – we consider the impact of our work on people and on the environment and uncover opportunities to make things better.

Certifications

Certifications can help you choose products that are environmentally sustainable and just right for your project. Sit2Stand has achieved the following certifications:

- AFRDI Green Tick Product Certification
- China Environmental Labeling Product Certification
- ANSI/BIFMA level Certified X5.5
- SCS Indoor Air Quality Gold

Product Data

Additional Product Information:

<http://www.steelcase.com/asia-en/products/desks/sit2stand/>



I. WORK POINTS

CHINA | VIP AREA | EXCLUSIVE PRICE - GESTURE CHAIR (Leather)



Image for visual purpose only

Seating Frame / Base / Leg color
 All Seating



Leather Options available



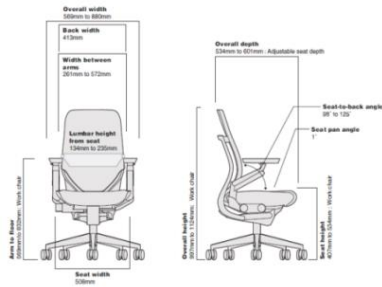
M351
 Black

Leg Color: Pricing provided is standard black.

All other color mix will be subjected to additional cost.

Note: Finishes price varies by fabric group and colors.
 Fabric price group 1 – No cost
 Fabric price group 2 – Additional cost
 Frame/Base/leg outside of standard will have additional cost.

PLAN VIEW



ABOUT THE SOLUTION

- Gesture shell back - Leather
- 3D LiveBack + 4D Arms
- Core equalizer
- Rectilinear arms with soft caps
- Casters
- Back frame, back shell, seat perimeter, arms and base are standard in black schemes
- Variable back stop with 4 positions
- Back tension
- Pneumatic adjustment mechanism
- Wrapped upper back upholstery design
- 360° arm enables 360° of motion to give arm support
- Soft arm caps
- Passive seat edge
- Lumbar height adjustment



Model Number:

442A30

Design Origin: America

LEADTIME: 6 – 8 weeks

Manufacturing Location: Dongguan, China

Gesture™ Chair - Features

Gesture™ is the first office chair designed to support a greater range of technologies, postures and user sizes. Inspired by the human body, designed for the way we work today.

360 Arm - Armrest height, depth, width and pivot



Height adjustable lumbar support

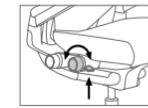


Seat depth adjustment

Back tension with Variable Back Stop

Seat height adjustment

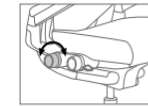
GESTURE CONTROLS



USER INTERFACE

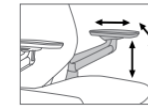
Seat Depth – To extend seat depth, remain seated and turn knob away from you. To retract, remain seated and turn knob toward you.

Seat height – To raise chair, lift your body weight and hold lever up. To lower chair, remain seated and hold lever up.



Back tension – Allows you to adjust the force required to sit upright or recline. Turn the knob forward for more resistance and backward for less resistance.

Variable Back Stop – This dial is located inset of the back tension knob. It allows four settings, upright lock, full recline, and two stops in between.



LIMB INTERFACE

360 Arm – A single release enables 360 degrees of motion, giving arm support wherever needed.

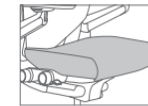
To adjust arm cap position, grasp arm caps and slide in any direction.



CORE INTERFACE

3D LiveBack™ – Provides sagittal, lateral, and torsional movement while maintaining persistent support.

Core Equalizer – Connects the seat to the back so they move together and provides just the right amount of lumbar support in any angle of recline.

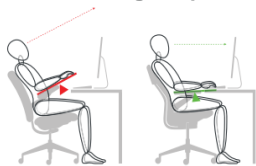


SEAT INTERFACE

Flexible edges – Designed with soft edges, comfort is extended to the edge of the seat.

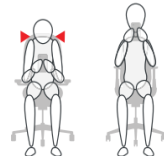
Adaptive bolstering – The Gesture seat is designed with air pockets carefully placed beneath the foam to give consistent comfort to a range of users.

Greater range of posture support and user sizes



SUPPORTING HEALTHY MOVEMENT

Gesture allows healthy movement and postures like reclining without pulling users away from their work.



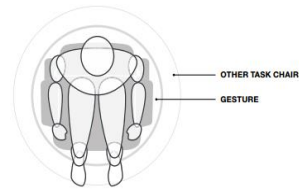
SUPPORTING MOBILE TECHNOLOGY

Gesture's supportive design helps prevent tech neck—an increasing health issue in the workplace. Highly adjustable arms enable users to bring small mobile devices in close and up to eye level, avoiding awkward and unhealthy postures.



SUPPORTING THE LOWER BACK

Gesture conforms to a user's back, preventing unhealthy postures that result from a lower back gap.



Meeting Spaces

- Huddle Space - Small
- Huddle Space - Large
- Internal Meeting Room
- External Meeting Room
- Training Room
- Video Conference Room



II. Meeting Spaces

Huddle Space Small



LOUNGE SETTING
Bfree Lounge

Huddle Space Large



SETTINGS
Media:scape Lounge



SETTINGS
SW_1 Lounge



SETTINGS
Media:scape Hoodie



SETTINGS
Campfire Big Table with
Cobi

How to classify selection

Each Huddle Space configuration shown above is divided into different option setting that is suitable in Huddle:

- **SMALL**
- **LARGE**



II. MEETING SPACES

CHINA | HUDDLE SPACE – SMALL | BFREE LOUNGE

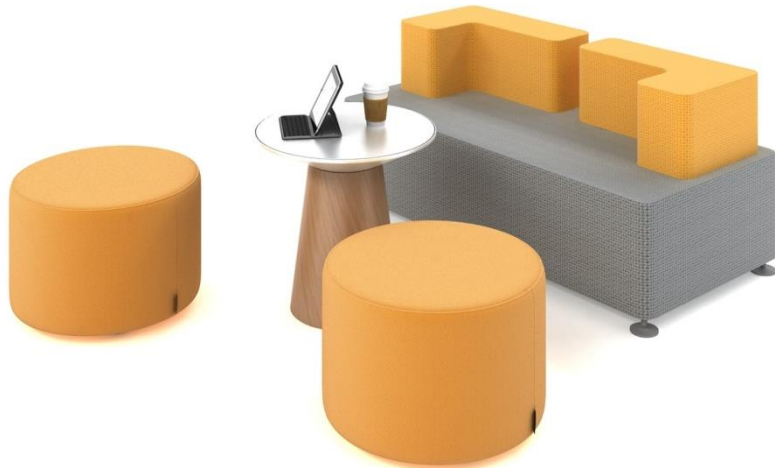
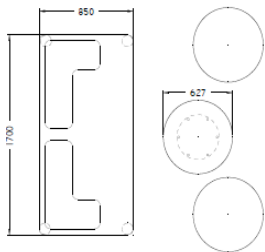


Image for visual purpose only

Seating – Group Buzz2 All Seating



PLAN VIEW



ABOUT THE SOLUTION

- B Free cube W/L Top block R/L 1700 W 430H 850D
- Campfire Alight Round Ottoman
- Campfire Paper table

Product Environmental Certifications



Model Number:

BFL300190
 CF34401
 CF4TPT

LEADTIME: 6 – 8 weeks

Manufacturing Location: Puchong, Malaysia



BFREE LOUNGE
LOUNGE PRODUCT

Product Information Packet

RESPONSE TO:

Huawei Technologies - Global

Request for Proposal

B-Free - Features

LOUNGE

Versatile, functional and comfortable, B Free Lounge enables the shaping of a wide range of settings to let individuals and teams connect, relax and create together.

Key Features

Promote Team Work

- Promotes informal exchanges, impromptu meetings, creative sessions, or simply a relaxing coffee break, which are at the heart of connecting, communicating, collaborating and creating.

Enhanced Ergonomics

- B-Free spaces work at stool or seated height to support short and long-term tasks.
- B-Free Lounge has a collection of 5 simple, geometrical, autonomous elements designed to be pieced together like a landscape.
 - Table
 - Beam
 - Cube with L top block
 - Cube
 - Table stool

Power Access

- The B-Free table leg has a hole option available for attaching technology units, allowing for power to always be within reach.

Certifications

Certifications can help you choose products that are environmentally sustainable and just right for your project. B-Free has achieved the following certifications:

- Geprüfte Sicherheit certificates
- SCS Indoor Air Quality Gold
- Cradle to Cradle

Product Data

Additional Product Information:

<https://www.steelcase.com/asia-en/products/lounge-seating/b-free/>





II. MEETING SPACES

CHINA | HUDDLE SPACE - LARGE



Image for visual purpose only

Laminate Desk & Table



Fabric for Workstation Screen – Buzz2 Fabric Covered Panel Skins, Bench Centered Screen & Side Screen



Paint All Tables



Seating Frame / Base / Leg color All Seating



ABOUT THE SOLUTION

A: media:scape Linear Lounge

- Personal table

B: media:scape Hoodie

- Paper table

C: SW_1 Lounge

- SW_1 Table

D: Campfire Big Table

- Cobi Stool

Model Number:

Media:scape Lounge

MLLHF
CF4TPT
CF4TWP
COEB4118L
COEB2723H

Model Number:

SW_1 Lounge

COWXLRND60
COW612

Model Number:

Media:scape hoodie

MLHEF
CF4TPT

Model Number:

Campfire Big Table & Cobi

CF4TLT28
434711

Product Environmental Certifications



Design Origin: North America & Europe

LEADTIME: 6 – 8 weeks

Manufacturing Location: Puchong, Malaysia
 Import from America

Turnstone Campfire Lounge - Features

LOUNGE

The turnstone Campfire Lounge collection is a flexible collection that allows you to create personal, intimate spaces, with the capability of becoming engaging collaborative spaces.

Why choose Campfire?

We don't need research to tell us that your best days happen when you have the flexibility to work in ways that best support your needs and give your creativity room to stretch. Campfire Lounge allows for endless configurations ranging from group lounge spaces to individualized areas designed for high focus.

Insights

Mingle

Expect the unexpected. Great things happen when a variety of people come together spontaneously. Create a favorite place to mix and mingle. Brainstorm toward a specific goal or see where some group dreaming takes you.

Meet

Not everyone's favorite four-letter word. Improve the attitudes and outcomes of meetings with a great place that oozes comfort and creativity. Standing height creates an inviting space with eye-level equality to collaborate and share, as well as supporting individual focus for the project at hand.

Escape

Often a change of scenery is just what you need for some fresh perspective and productivity. Escape places are comfortable and signal to others that you need a little focus time.

Certifications

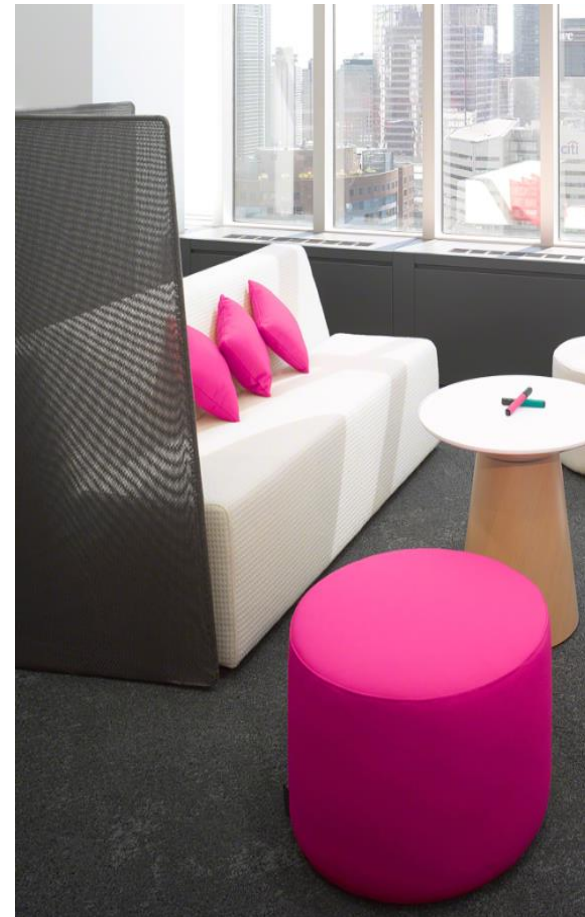
Certifications can help you choose products that are environmentally sustainable and just right for your project. Turnstone Campfire has achieved the following certifications:

- BIFMA X5.5-2014 Desk/Table Products
- ANSI/BIFMA X5.9-2012 Storage Units
- SCS IAQ Gold

Product Data

Additional Product Information:

<http://www.steelcase.com/asia-en/products/lounge-seating/turnstone-campfire/>



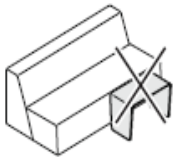
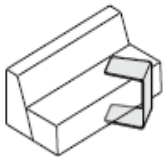
Turnstone Campfire Lounge - Features

AVAILABLE SIZES:

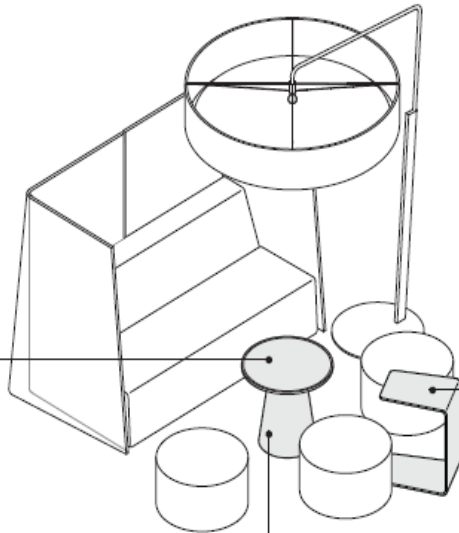
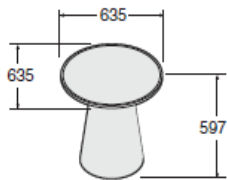
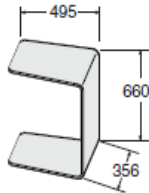
Specification Information

Paper Table			
D	W	H	Style Number
635	635	410	CF34401
Personal Table			
D	W	H	Style Number
495	356	660	CF4TWP

Product Details



Personal table is designed to be used only in vertical position



Paper table has three top configurations:
 • Paper (installed over steel table top tray)
 • Glass (installed over steel table top tray)
 • Steel table top tray

Paper table is constructed with laminate base, plastic rotating table top, and steel table top tray.

Personal table is constructed of bent plywood with rift-cut natural oak veneer finish. It nests underneath Big Lounge and can be used as a writing surface for laptops.

Note: The angle is not approved to be used for food or drinks. The personal table is not intended to be sat or stood on.



Disclaimer: Quotation will be provided based on actual project scheduled.

media:scape Lounge - Features

LOUNGE

media:scape Lounge was designed to create collaborative work settings to support teams. It integrates seamlessly with media:scape. In addition to that, the new Linear Lounge made especially for Asia Pacific provides three extra elements: angled linear, 2-seater linear, and the flexible hexagon.

Why choose Big Table?

media:scape lounge was developed to feature innovative configurations in highly attractive finishes. It went a step further by integrating media into the furniture solution allowing people to project, share and access digital information even in informal settings. It's versatile geometry can be easily reconfigured to support small teams of 4-6 people, and to collaborate around digital content comfortably.

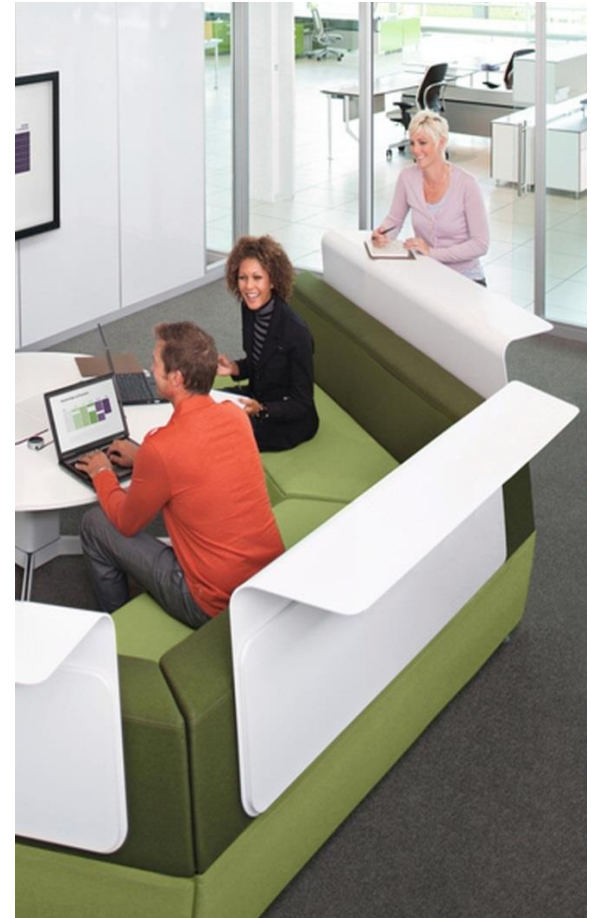
Key Features

- It comes in eight unique lounge pieces; straight, straight inverted, backless, right corner, left corner, reverse left, reverse right and hexagon.
- Lounge seating creates collaborative work settings designed to support small teams of four or more people.
- Canopy transforms the level of privacy - creating an informal, semi-enclosed meeting experience.
- Ledge invites participation and provides a work surface for a second row of tiered seating.
- Table support personal devices with multiple power outlets, data ports, and PUCKs within reach.
- media:scape Lounge is available in three different fabric orientation.

Surface Materials

Available in three different fabric orientations;

- Entire lounge as one fabric
- Top of the lounge is one fabric while sides are second fabric
- Seat surface and back is one fabric while all other panels are a second fabric



media:scape Lounge - Features

media:scape Lounge was designed to create collaborative work settings to support teams. It also integrates seamlessly with media:scape.

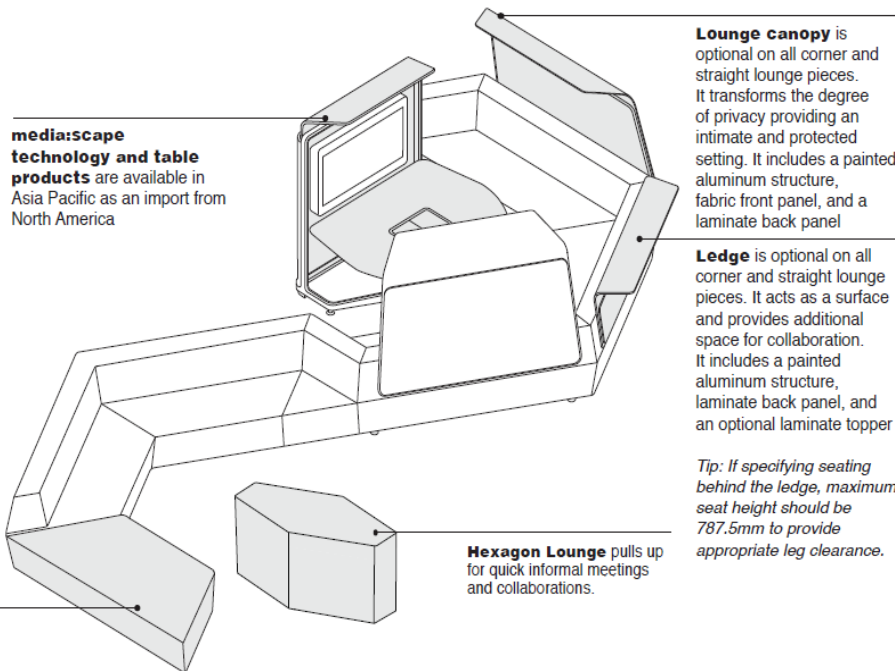
Product Details

media:scape lounge creates collaborative work settings designed to support small teams of four to six people.

media:scape lounge is the lounge series to the media:scape product line. For technology products and table products, please refer to North America Selected imports Spec Guide.

media:scape lounge offers nine lounge pieces: straight, straight inverted, backless, right corner, left corner, reverse left, reverse right, linear and hexagon. The lounge is designed to be easily reconfigured in many different ways to accommodate multiple settings. There are three different fabric finishes to choose from. It is recommended to use solid, non-patterned fabrics. Steelcase will not pattern match fabrics which have a distinct repeating pattern.

Lounge fabric is available in Asia Pacific in Price Group 2 only. Customers Own Material is also available.



Disclaimer: Quotation will be provided based on actual project scheduled.

media:scape Hoodie - Features

media:scape Lounge was designed to create collaborative work settings to support teams. It also integrates seamlessly with media:scape.

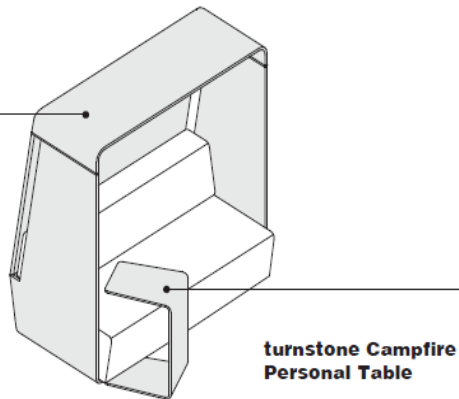
Product Details

media:scape Lounge Hood creates a space that allows for focus, reflection and quick collaboration.

media:scape Lounge Hood has unique acoustic properties that create optional environments for meeting and focused task.

It allows for the customization of color finishes in Asia Pacific Price Group 2.

media:scape Lounge Hood design allows for privacy or an area of reflection and can also be paired with media:scape technology



Disclaimer: Quotation will be provided based on actual project scheduled.



II. Meeting Spaces

Enclosed Meeting Room (Internal)



SMALL
Lexicon (2 People)



MEDIUM
Lexicon (10 People)



LARGE
Lexicon (18 People)

Enclosed Meeting Room (External)



SMALL
4.8 Round Table (4 People)



MEDIUM
4.8 Meeting Table (6 People)



LARGE
4.8 Meeting Table (14 people)

How to classify and use.

Each Meeting configuration shown above is divided into 2 different Room:

- **INTERNAL** – Internal Staff to use
- **EXTERNAL** – For External Clients

Configuration shown above is divided into:

- **SMALL** – 2 people
- **MEDIUM** – 6 – 12 people
- **LARGE** – 12 – 20 people



II. MEETING SPACES

CHINA | INTERNAL MEETING ROOM | SMALL - 2 PEOPLE



Image for visual purpose only
 Chairs are not included in the price

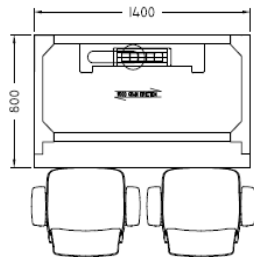
Laminate
 Desk & Table



Paint
 All Tables



PLAN VIEW



ABOUT THE SOLUTION

- Lexicon Single Sided desk 1400W 800D 720H
- Cutout for 3 power for AH Meyer Netbox

Product Environmental Certifications



Model Number:

46029-LDFS11480
 WTEUFCS

Design Origin: Asia Pacific

LEADTIME: 6 – 8 weeks

Manufacturing Location: Dongguan, China



II. MEETING SPACES

CHINA | INTERNAL MEETING ROOM | MEDIUM - 10 PEOPLE



Image for visual purpose only
 Chairs are not included in the price

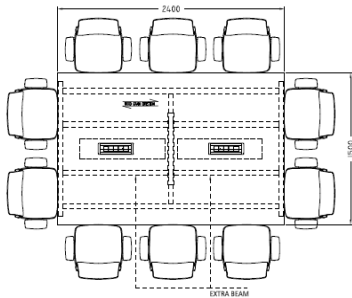
Laminate
 Desk & Table



Paint
 All Tables



PLAN VIEW



ABOUT THE SOLUTION

- Lexicon Freestanding Bench 2400W 1500D 720H
- Cutout for 3 power for AH Meyer Netbox

Product Environmental Certifications



Model Number:

46029-
 LBFD2CA2415
 LBUDAVCC
 INA09CT

Design Origin: Asia Pacific

LEADTIME: 6 – 8 weeks

Manufacturing Location: Dongguan, China



II. MEETING SPACES

CHINA | INTERNAL MEETING ROOM | LARGE - 18 PEOPLE



Image for visual purpose only
 Chairs are not included in the price

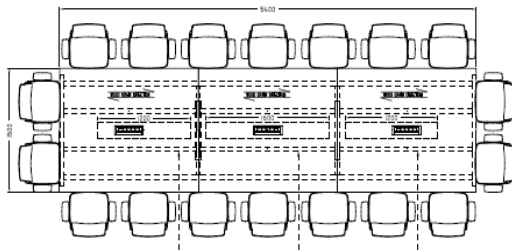
Laminate
 Desk & Table



Paint
 All Tables



PLAN VIEW



ABOUT THE SOLUTION

- Lexicon Freestanding Bench 5400W 1500D 720H
- Cutout for 3 power for AH Meyer Netbox

Product Environmental Certifications



Model Number:

46029-LBFD3A5415
 LBUDAVCC
 INA12CT
 INA16CT

Design Origin: Asia Pacific

LEADTIME: 6 – 8 weeks

Manufacturing Location: Dongguan, China



II. MEETING SPACES

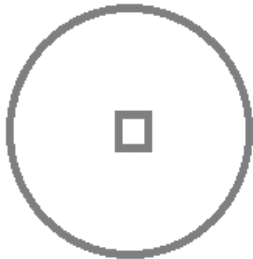
CHINA | EXTERNAL MEETING | SMALL - 4 PEOPLE



Image for visual purpose only
 Chairs are not included in the price



PLAN VIEW



ABOUT THE SOLUTION

- 4.8 Meeting Table (Round) - Veneer
- 1250Diameter
- Laminate top options is available with lower cost.

Product Environmental Certifications



Model Number:

48ST125RD1CVC
 48SSRDSSW
 48AMCTRDSSP

Design Origin: Europe

LEADTIME: 6 – 8 weeks

Manufacturing Location: Dongguan, China



II. MEETING SPACES

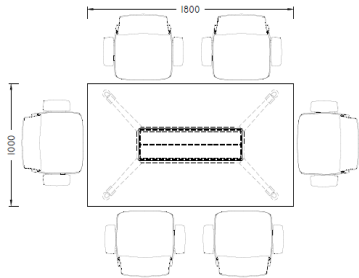
CHINA | EXTERNAL MEETING | MEDIUM - 6 PEOPLE



Image for visual purpose only
 Chairs are not included in the price



PLAN VIEW



ABOUT THE SOLUTION

- 4.8 Meeting Table Rectangular - Veneer
- 1800W 1000D
- Laminate top options is available with lower cost.
- *Seating is not included*

Product Environmental Certifications



Model Number:

48ST1810ST1CVC
 48SS1810W
 48AMCT1800P

Design Origin: Europe

LEADTIME: 6 – 8 weeks

Manufacturing Location: Dongguan, China



II. MEETING SPACES

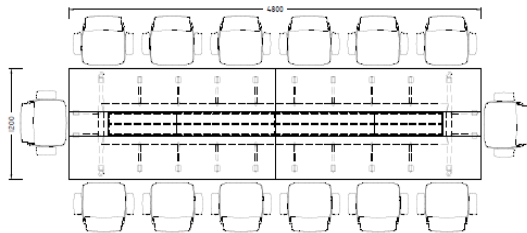
CHINA | EXTERNAL MEETING | LARGE - 14 PEOPLE



Image for visual purpose only
 Chairs are not included in the price



PLAN VIEW



ABOUT THE SOLUTION

- 4.8 Meeting Table Rectangular - Veneer
- 4800W 1200D
- Laminate top options is available with lower cost.
- *Seating is not included*

Product Environmental Certifications



Model Number:

48MT4812ST6CVC
 48MS4800W
 48AMCT4800P

Design Origin: Europe

LEADTIME: 6 – 8 weeks

Manufacturing Location: Dongguan, China



II. Meeting Spaces

Training Room



SMALL
FlipTopTwin Table (2
People)

Video Conference Room



SMALL
Verb Table (2 People)

How to classify selection

Configuration shown above is divided into different setting of:

- TRAINING
- VIDEO CONFERENCE ROOM



II. MEETING SPACES

CHINA | TRAINING ROOM



Image for visual purpose only
 Chairs and power are not included in the price

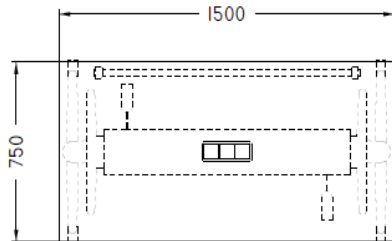
Laminate Desk & Table



Paint All Tables

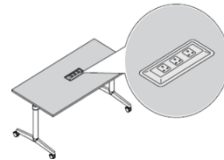


PLAN VIEW



ABOUT THE SOLUTION

- Flip Top Twin 1500W 750D 720H with 3 Power
- Without Modesty Panel
- Power options is available with additional cost.



Product Environmental Certifications



Model Number:

46034-CFTT1575-C
 CFTTMOD15
 CFTTPLCO
 C46034-NBL3GPPP-
 AU
 VPSCBL30S1A

Design Origin: Europe

LEADTIME: 6 – 8 weeks

Manufacturing Location: Dongguan, China

FlipTopTwin - Features

VERSATILE USE OF SPACE

FlipTop Twin is a clever and flexible table for meeting or training rooms. Very intuitive, the top can be flipped from both sides. Once the top is flipped, the tables can be stored to save space

Why choose FlipTop Twin?

Intelligent products can significantly reduce the costs associated with conference rooms by increasing their rate of use. Users need facilities to be flexible; they need to be able to set up different configurations quickly and easily and to handle speedy changeovers between training sessions, group meetings or conferencing. FlipTop Twin has been specifically conceived for this purpose and offers a multiplicity of uses and simple mechanisms.

Key Features

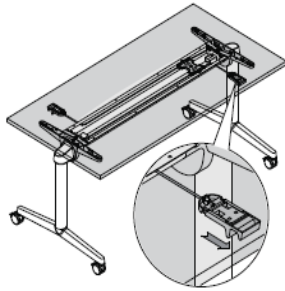
- Quick and easy installation as it is 100% symmetric. The top can be flipped to both sides either by hand or foot and it can be used from both sides.
- Space efficiency due to its flexibility and modularity.
- Integrated cable management solution. Pre-assembled electrification allows quick installation and easy user access to power.
- The pre-assembled electrification allows quick installation and easy user access to power and data.
- Some handles have a double click function to avoid unintentional use.



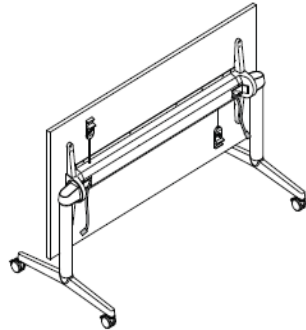
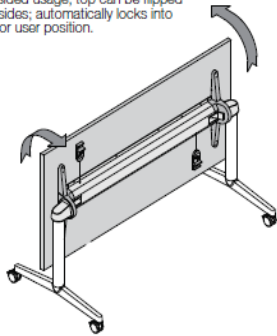
FlipTopTwin - Features

FlipTop Twin™ is a clever and flexible table for meeting or training rooms. Very intuitive, the top can be flipped from both sides. Once the top is flipped, the tables can be stored to save space.

Flip Mechanism



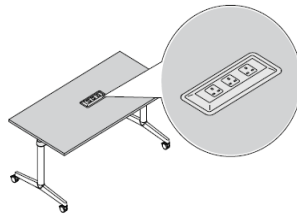
Tool-free folding mechanism, double-sided usage, top can be flipped to both sides; automatically locks into parking or user position.



Connection cable

- Pre-assembled for quick and easy connection.
- Starter cable has to be ordered separately

Power Options



PowerBox

- Power Box option: comprises built-in power with option of either triple socket or double socket with switch.
- Power box of size W188mmxD61mm is embedded in the center of table.



Cable tray

- Sheet steel, powder-coated with epoxy resin screws into top, H65mm, bevelled edges
- Double-sided access to cable passage on underside
- Horizontal cable passage: concealed in cable tray

Sustainability

Designing for sustainability

We believe the only way to provide the best office furniture solutions is to ensure they're the best products for the environment. That's why every step of the way – through design, manufacturing, delivery and product lifecycle – we consider the impact of our work on people and on the environment and uncover opportunities to make things better.

Certifications

Certifications can help you choose products that are environmentally sustainable and just right for your project. FlipTop Twin has achieved the following certifications:

- SCS Indoor Advantage Gold certified for indoor air quality
- China Environmental Labeling Product Certification

Product Data

Additional Product Information:

<https://www.steelcase.com/asia-en/products/tables/fliptop-twin/>



II. MEETING SPACES

CHINA | VIDEO CONFERENCE ROOM



Laminate
 Desk & Table

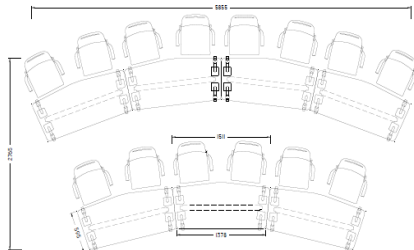


Paint
 All Tables



Image for visual purpose only
 Chairs are not included in the price

PLAN VIEW



ABOUT THE SOLUTION

- Verb (Chevron)
- 1500W x 600D x 727H
- With lockable Castor

Product Environmental Certifications



Model Number:

VTC1566

Design Origin: Americas

LEADTIME: 6 – 8 weeks

Manufacturing Location: Dongguan, China



VERB
TRAINING TABLE

Product Information Packet

Verb - Features

CONFERENCE + CLASSROOM TABLES

Verb is an integrated collection of classroom furniture including tables, whiteboards, and instructor stations designed to support a full range of teaching and learning styles.

Why choose Verb?

Classroom furniture must be mobile, versatile and offer simple, seamless transitions for multimodal teaching and learning styles.

Key Features

Verb classroom tables are specifically designed to support different learning modes. The chevron shaped table improves sight lines, encourages collaboration and helps define personal work area.

- Verb classroom tables are specifically designed to support different learning modes. The chevron shaped table improves sight lines, encourages collaboration and helps define personal work area.
- The Verb instructor station is ideal for instruction, collaboration, and concentrated work. The desk and integrated lectern support teaching – whether standing, perched or seated.
- The Verb whiteboard is the foundation for collaboration, display and presentation in the classroom, perfect for active learning.
- The Verb whiteboard easel allows for effective display, storage and presentation of Verb whiteboards, wherever collaboration might occur in the classroom. Multiple options for wall track and hooks provide even more opportunities for presentation.

Certifications

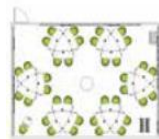
Certifications can help you choose products that are environmentally sustainable and just right for your project. Verb has achieved the following certifications:

- ANSI/BIFMA X5.5
- SCS Indoor Advantage Gold certified for indoor air quality
- China Environmental Labeling Product Certification

Product Data

Additional Product Information:

<https://www.steelcase.com/asia-en/products/desks/verb/>



As a system, Verb supports multiple pedagogies and learning styles, allowing for fluid transitions between modes.



Chevron design allows eye contact to be maintained, even in lecture mode.



Team modes are for longer duration projects.

Work Support Spaces

- Collaboration Area
- Locker
- Compactus
- Pedestal
- Worktools



III. Work Support Spaces

Collaboration Area



TABLE
Campfire Big Table



STOOL CHAIR
Scoop



LOUNGE
media:scape Lounge



LOUNGE
media:scape Linear



LOUNGE
Hoodie



LOUNGE
BrodyLounge



LOUNGE
Hosu



LOUNGE
Lagunitas

How to classify selection

Cafe configuration shown has 3 product type proposed:

- TABLE
- STOOL
- LOUNGE



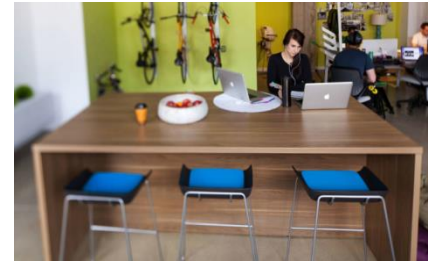
III. WORK SUPPORT SPACES

CHINA | COLLABORATION AREA | CAMPFIRE BIG TABLE



Image for visual purpose only

Laminate
Desk & Table



ABOUT THE SOLUTION

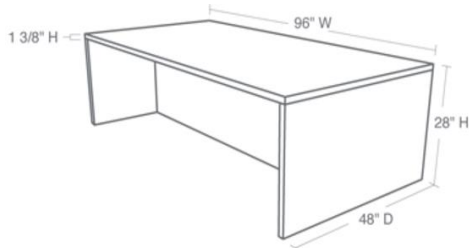
- Campfire Big Table (non-powered version)
- available in two heights: seated (28") or standing (40")
- full surface available
- split surface available with center trough for access to power and storage
- Power available with additional cost.

Product Environmental Certifications



Model Number:

CF4TLT28



Design Origin: America

LEADTIME: 6 – 8 weeks

Manufacturing Location: Americas



CAMPFIRE BIG TABLE
SOCIAL & MEETING TABLE

Product Information Packet

RESPONSE TO:

Huawei Technologies - Global

Request for Proposal

Turnstone Campfire Big Table - Features

TABLE

Big Table was inspired by the way people gather in social and collaborative settings, the center of attraction that naturally draws people together to share, collaborate and create. Its clean simple lines makes it extremely versatile, a great place to get a team together to workshop, or for smaller teams to spread their work out and share information visually.

Why choose Big Table?

CREATE VERSATILE SPACES FOR TEAM WORK

With increasing collaboration time spent in informal and unstructured work, Campfire Big Table provides a focused space and support for effective interaction and productive collaboration. A clear worksurface and easy integration of technology enhance sharing, while a choice of heights supports working while seated – or standing.

Foster Collaboration With Standing Height

Standing height Big Table creates a comfortable height for team interaction and democratic eye-to-eye contact, expanding the available palette of posture and place, and contributing to individual wellbeing.

Support Informal Collaboration

Big Table provides a more space-efficient option than dedicated team project or meeting rooms, defining open team spaces for impromptu meetings through to embedded projects without the commitment and real estate requirements of walled rooms.

Make Social Spaces More Dynamic

Adding the Big Table to coffee areas or lobbies creates high value collaborative and touchdown spaces.

Certifications

Certifications can help you choose products that are environmentally sustainable and just right for your project.

Turnstone Campfire Big Table has achieved the following certifications:

- BIFMA X5.5-2014 Desk/Table Products
- SCS IAQ Gold

Product Data

Additional Product Information:

<https://www.steelcase.com/asia-en/products/tables/big-table/>



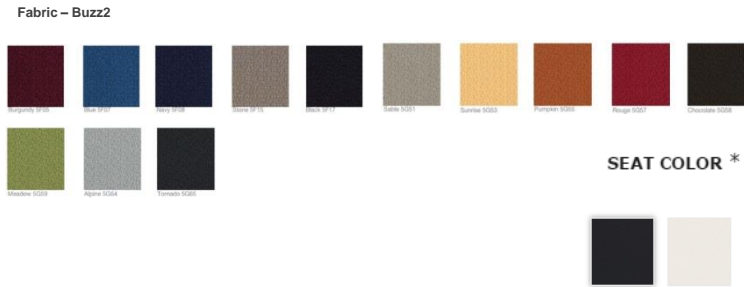


III. WORK SUPPORT SPACES

CHINA | COLLABORATION AREA | SCOOP STOOL CHAIR



Image for visual purpose only



ABOUT THE SOLUTION

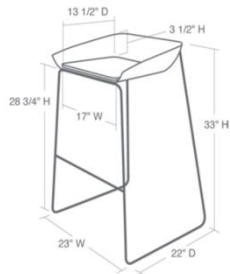
- Scoop Stool
- With cushion

Product Environmental Certifications



Model Number:

TS30702



Design Origin: America

LEADTIME: 12 – 14 weeks

Manufacturing Location: Dongguan, China

Scoop - Features

SEATING

Inspired by a grain scoop, this casual stool will support your creative interactions and need for expression. Minimalist lines make a simple statement, while cushions of color pop with comfort.

Why choose Scoop?

Scoop packs durability and functionality into one clean, simple design. Its generous seat and optional upholstery make it an instant favorite.

Key Features

- Durable wire rod frame available in Black or Platinum Metallic
- Molded plastic seat in two colors: white or cobblestone
- Optional upholstered seat cushion
- level™ 1 certified to BIFMA e3 standard
- Cradle to Cradle™ Product Certification for environmental performance - Silver
- SCS Indoor Advantage™ certification for protecting indoor air quality – Gold

Product Data

Additional Product Information:

<https://www.steelcase.com/products/guest-chairs-stools/scoop/>





III. WORK SUPPORT SPACES

CHINA | COLLABORATION AREA | MEDIASCAPE LOUNGE



Fabric – Buzz2



Image for visual purpose only

ABOUT THE SOLUTION

- media:scape corner lounge – Left & Right
- media:scape straight lounge
- Hexagon
- Campfire Personal Table

Product Environmental Certifications



Model Number:

- MLLCS
- MLRCS
- MLSTS
- MLXLS
- CF4TWP

Design Origin: America

LEADTIME: 6 – 8 weeks

Manufacturing Location: Puchiong, Malaysia



III. WORK SUPPORT SPACES

CHINA | COLLABORATION AREA | MEDIASCAPE LINEAR



Fabric – Buzz2



Image for visual purpose only

ABOUT THE SOLUTION

- media:scape Linear (3 Seater)
- Canopy

Product Environmental Certifications



Model Number:

MLLF
MLCAN

Design Origin: America

LEADTIME: 6 – 8 weeks

Manufacturing Location: Puchiong, Malaysia



III. WORK SUPPORT SPACES

CHINA | COLLABORATION AREA | MEDIASCAPE HOODIE



Fabric – Buzz2



Image for visual purpose only

ABOUT THE SOLUTION

- media:scape Hoodie (1 unit)
- Hood with 2 seater linear

Product Environmental Certifications



Model Number:

MLHBF

Design Origin: America

LEADTIME: 6 – 8 weeks

Manufacturing Location: Puchiong, Malaysia



III. WORK SUPPORT SPACES

CHINA | COLLABORATION AREA | BRODY WORKLOUNGE



Fabric – Buzz2



Image for visual purpose only

ABOUT THE SOLUTION

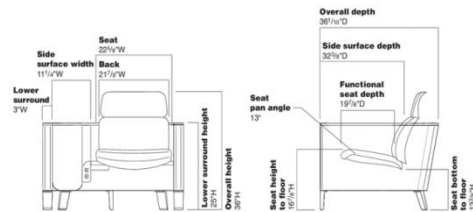
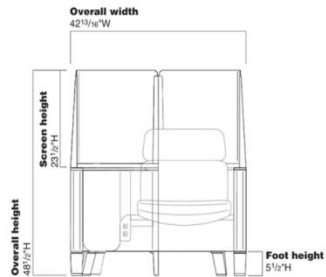
- Brody Work Lounge
- Leg Rest Cushion

Product Environmental Certifications



Model Number:

488WE
 488FR



Design Origin: America LEADTIME: 12 – 14 weeks

Manufacturing Location: Americas

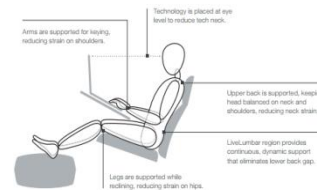
Brody WorkLounge - Features



Designed to be good for your body and good for your brain.

Introducing the Brody™ WorkLounge.

Providing high-performance comfort and support, the Brody WorkLounge features patented LiveLumbar™ technology—bringing thoughtful ergonomic design to the lounge posture. The adjustable, personal worksurface holds technology at eye level, reducing neck and shoulder strain.



IM#: 15-0007418

PERSONAL WORKSURFACE

With up to 40° of pitch, this highly-adjustable worksurface lets you position your work and your devices precisely where you want them.



IM#: 15-0007402

PRIVACY SCREEN

Privacy screens help reduce visual distractions and enhance personal privacy and comfort.



IM#: 15-0007425

PERSONAL STORAGE

Personal storage provides a convenient place to store your belongings up off the floor and within arm's reach.



IM#: 15-0007426

FOOTREST

Additional support for legs and feet helps maintain comfortable, reclined postures, with a nonslip surface that prevents movement. Footrest fits under the seat when not in use.



IM#: 15-0007407

LIGHTING

The dash® mini LED task light integrates seamlessly to deliver adjustable, efficient lighting where you need it most.



IM#: 15-0007411

POWER

Integrated power is easily accessible, so you can focus on your work—not your battery level.



III. WORK SUPPORT SPACES

CHINA | COLLABORATION AREA | HOSU

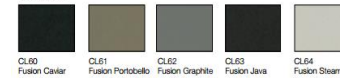


Image for visual purpose only

Surface Materials
 Hexa standard fabric



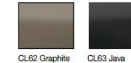
Fusion fabric



Pull tab colors



Footrest colors



ABOUT THE SOLUTION

- Hosu Lounge with Ottoman and lumbar pillow.



Overall: 35³/₈"D 34¹/₈"W 35"H
 Overall extended: 57"L
 Inside: 24"D 31"W 14"H
 Inside extended: 48"L
 Pillow: 3"D 20¹/₂"W 10¹/₂"H
 Ottoman: 24"D 31"W 8¹/₂"H

Design Origin: America

Product Environmental Certifications



Model Number:

COURQLO

LEADTIME: 12 – 14 weeks

Manufacturing Location: Americas

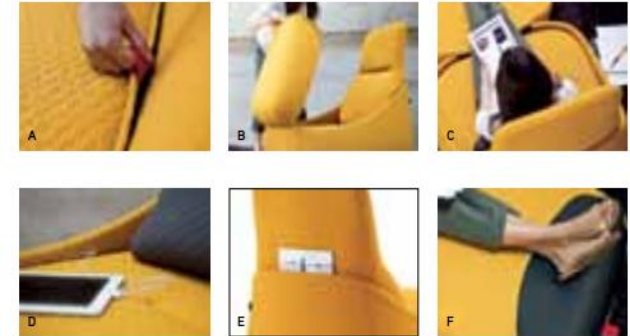
Hosu - Features



Comfortable. With the increasing demands of the new work day, creative people value places to work in a relaxed mode in the office or on the go.



Product Features



Lounge convertible

- Available upholstered in custom designed Hexa fabric (A)
- Converts from a lounge to an extended low lounge with attached ottoman using pull tab (A, B, C)
- Wire pass through at the base (D)
- Side and rear pockets for light storage (E)
- Standard with a soft lumbar pillow (D)
- Ultraleather Fusion Fabric in caviar (black) on ottoman footrest is soft, durable and easy to clean (F)
- Large glides

Lounge

- Available upholstered in custom designed Hexa fabric
- Side and rear pockets for light storage
- Standard with attached soft lumbar pillow
- Large glides

Sofa

- Available upholstered in custom designed Hexa fabric
- Side and rear pockets for light storage
- Standard with two attached soft lumbar pillows
- Large glides



III. WORK SUPPORT SPACES

CHINA | COLLABORATION AREA | LAGUNITAS



Image for visual purpose only

Surface Materials

Standard Knit



SK58 Ivory SK50 Stone SK51 Grey SK59 Coal SK54 Black

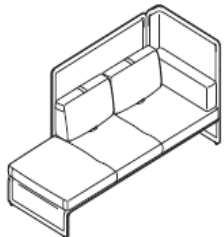
Knit on Demand



SK80 Glacier SK56 Golden SK64 Amber SK55 Garnet SK69 Khaki SK61 Cadet SK82 Grass SK65 Terracotta
 SK67 Berry SK52 Cement SK57 Royal SK63 Forest SK66 Crimson SK68 Violet SK53 Brown

ABOUT THE SOLUTION

- Three-Seat Chaise with Two Articulating Backs, High-Back
- With screen



Overall: 85"W x 34"D x 50"H
Seat: 16"H

Design Origin: America

Product Environmental Certifications



Model Number:
 COLAGCH3

LEADTIME: 12 – 14 weeks

Manufacturing Location: Americas

Lagunitas - Features



Social spaces are today's new workspaces. Working alone or together, people seek a lively place with energy and vibe. With 67 unique pieces, Lagunitas creates the ideal space for any work setting. The comprehensive seating and tables collection infuses comfort and well-being, power and storage, all into a single system.



Product Features



- A. Articulating back cushion handle
- B. Integrated power options-seating, shown with USB power module
- C. Integrated power options-tables, shown with PowerPod
- D. Integrated power options-tables, shown with USB power module
- E. Veneer edgeband detail
- F. Laminate edgeband detail
- G. Table base and column with hidden wire management through column





III. Work Support Spaces

Locker



**LOCKER
UPV**

Pedestal



**STORAGE
UPV Pedestal**



**STORAGE
UPV Pedestal (Customized
Lehman Lock)**

Compactus Room



**COMPACTUS
UPSS**

How to classify selection

Each product shown above are types of storages proposed for:

- LOCKERS
- COMPACTUS ROOM
- PEDESTAL
- WORKTOOLS



III. Work Support Spaces

Worktools



WORKTOOLS
Single Monitor Arm
Volley (Desk Clamp)



WORKTOOLS
Single Monitor Arm
Volley (Lexicon C-clamp)



WORKTOOLS
Dual Monitor Arm
Volley (Desk Clamp)



WORKTOOLS
Dual Monitor Arm
Volley (Lexicon C-Clamp)



WORKTOOLS
Notebook Holder



WORKTOOLS
Markerboard



WORKTOOLS
Name Tag

How to classify selection

Each product shown above are types of storages proposed for:

- LOCKERS
- COMPACTUS ROOM
- PEDESTAL
- WORKTOOLS



III. WORK SUPPORT SPACES

CHINA | LOCKER | UPV LOCKER

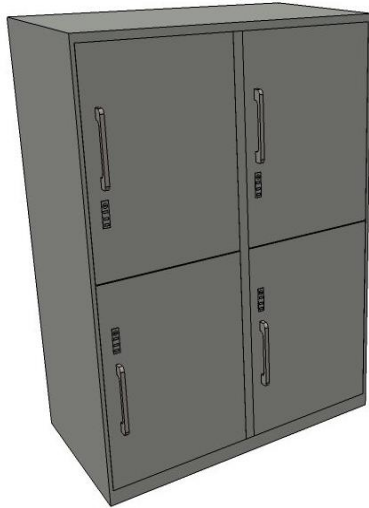
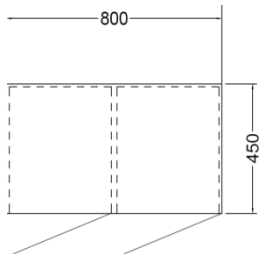


Image for visual purpose only

Paint



PLAN VIEW



ABOUT THE SOLUTION

- UPV series locker
- LPL Top
- Adjustable Shelf within

Product Environmental Certifications



Model Number:
C46752-UPV3458107L
DC845TN

Design Origin: Asia Pacific

LEADTIME: 6 – 8 weeks

Manufacturing Location: Dongguan, China

RESPONSE TO:

Huawei Technologies - Global

Request for Proposal

UPV - Features

STORAGE

The UPV Series provides flexible, cost-efficient, space-saving storage solution that brings a sense of order to the workplace. Its wide range of options helps meet diverse storage needs and design aesthetics.

Why choose UPV Series Storage?

The UPV Series provides flexible, cost-efficient, space-saving storage solutions to help bring a sense of order to the modern workplace. A wide range of sizes, varieties and options such as open shelves, lateral filing, tambour and hinge doors, meet diverse storage needs and design aesthetics. The small footprints help to optimize the efficient use of space.

Customizable Colors

Available in Steelcase core and accent paint colors, the case, drawer and handle pulls can be specified in any of these colors, allowing for a wide range of looks to fit your workspace.

Choice Of Styles

UPV is available in a range of size and shapes with options including:

- Mobile pedestal
- Fixed pedestal
- Caddy: open shelf
- Caddy: tambour steel doors
- Hinged steel two doors
- Hinged steel single door
- Sliding steel doors
- Tambour steel doors
- Open shelf
- Lateral
- Plant holders

Hinged Steel Two Doors

- Large hinged door units offer extensive storage capacity.
- Available in 4 heights, adjustable shelves provide flexibility for storing both large and small items.





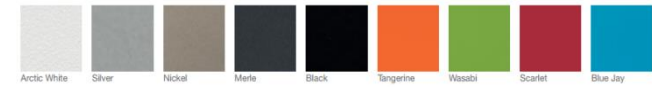
III. WORK SUPPORT SPACES

CHINA | COMPACTUS | UPSS COMPACTUS – 5 BAYS

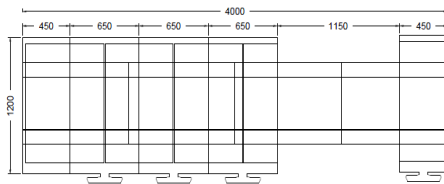


Image for visual purpose only

Paint



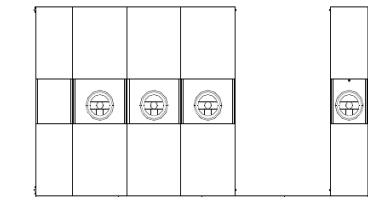
PLAN VIEW



ABOUT THE SOLUTION

- UPSS
- 450D 1200W 2160H
- Mech Compactus 1-bay
- Single fixed w/ back panel
- Individual locks are available with additional cost.

Design Origin: Asia Pacific



Model Number:

- C47752-UPSSB1SF412
- C47752-UPSSB1SM412
- C47752-UPSSB1DP612
- C47752-UPSS-RB1
- C47752-UPSS-PB112
- C47752-UPSS-PS6512
- C47752-UPSS-PS8512

LEADTIME: 6 – 8 weeks

Manufacturing Location: Dongguan, China

RESPONSE TO:

Huawei Technologies - Global

Request for Proposal

UPSS - Features

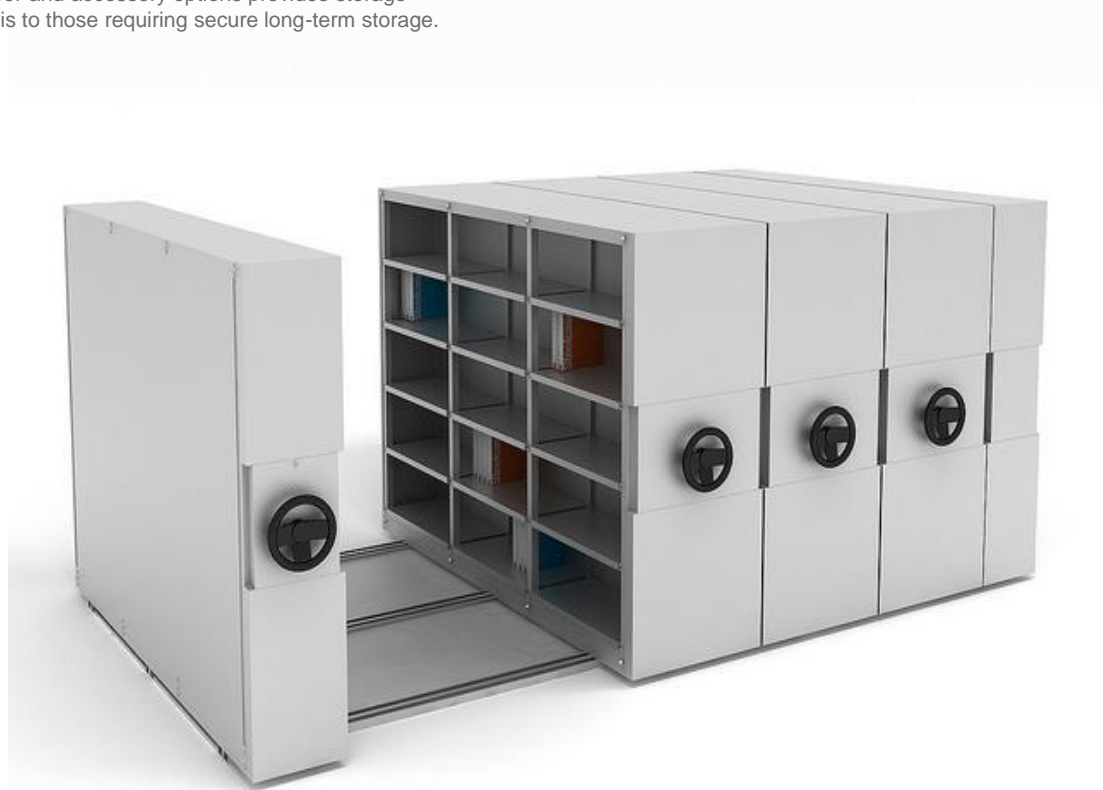
STORAGE

UPSS offers a comprehensive range of storage solutions designed to enhance workplace efficiency and optimize the use of space. With a simple design, excellent functionality, and a small footprint, UPSS units mix and match to fit in to every workplace. A large menu of units with various door, shelving, drawer and accessory options provides storage solutions for a wide range of user needs, from items used on a daily basis to those requiring secure long-term storage.

Choice Of Styles

UPSS is available in a range of size and shapes with options including:

- Sliding door cabinet
- Hinged door cabinet
- Hinged glass door cabinet
- Open shelf
- Vertical drawer cabinet
- Mobile pedestal
- Tambour door cabinet
- Locker
- Magazine rack
- Lateral drawer cabinet
- Manual compactus
- Mechanical compactus



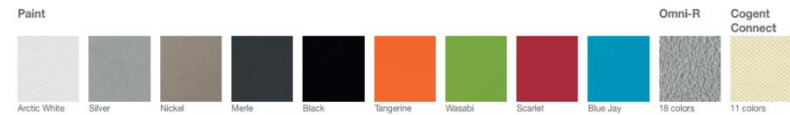


III. WORK SUPPORT SPACES

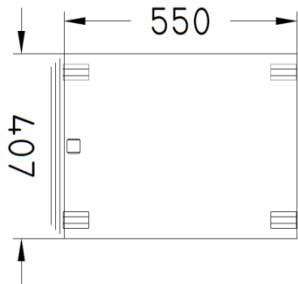
CHINA | PEDESTAL | UPV MOBILE PEDESTAL



Image for visual purpose only



PLAN VIEW



ABOUT THE SOLUTION

- UPV series
- Pencil/Box/File
- Castor
- Cushion top is available with additional cost.

Note: Price inclusive of standard mobile pedestal only.

Product Environmental Certifications



Model Number:

UPVMPPBF407

Design Origin: Asia Pacific

LEADTIME: 6 – 8 weeks

Manufacturing Location: Dongguan, China

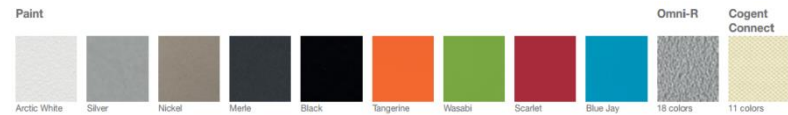


III. WORK SUPPORT SPACES

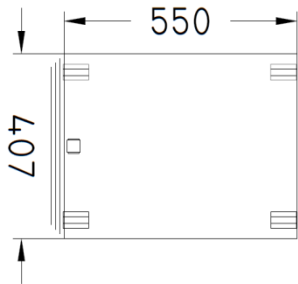
CHINA | PEDESTAL | UPV MOBILE PEDESTAL WITH SPECIAL LEHMAN LOCK



Image for visual purpose only



PLAN VIEW



ABOUT THE SOLUTION

- UPV series
- With special Lehman Lock
- Pencil/Box/File
- Castor
- Cushion top is available with additional cost.

Design Origin: Asia Pacific

Note: Price inclusive of special mobile pedestal with special Lehman lock.

Product Environmental Certifications



Model Number:

C46875-UPVMPPBF407

LEADTIME: 6 – 8 weeks

Manufacturing Location: Dongguan, China



IV. WORK SUPPORT SPACES

CHINA | WORKTOOLS | SINGLE MONITOR ARM – VOLLEY (DESK CLAMP)



Image for visual purpose only

- Paint
- Brushed Aluminum
 - White Accents

ABOUT THE SOLUTION

- 240mm minimum vertical adjustment range
- Supports monitors up to 7kg
- 75mm and 100mm VESA compatible fixing plate
- 360° monitor and arm rotation
- Maximum size of monitor is 24"

Model Number:
WTMA523

Design Origin: America

LEADTIME: 6 – 8 weeks

Manufacturing Location: Dongguan, China

Volley Monitor Arm - Features

WORKTOOLS

Straightforward understated design and a simple statement of line.

Technical Information

- Dynamic height-adjustment
- 240mm minimum vertical adjustment range
- Supports monitors up to 7kg
- 75mm and 100mm VESA compatible fixing plate
- 360° monitor and arm rotation
- Monitor quick connect/disconnect
- Integrated cable management
- Grommet mount, Slatwall mount and C-clamp
- Swivel limiters prevent Volley from colliding into screens or walls
- Maximum size of monitor is 24"



QUICK CONNECT MOUNT

Allows users to switch monitors quickly and efficiently.





IV. WORK SUPPORT SPACES

CHINA | WORKTOOLS | SINGLE MONITOR ARM – VOLLEY (LEXICON C-CLAMP)

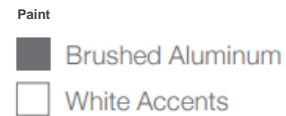


Image for visual purpose only

ABOUT THE SOLUTION

- 240mm minimum vertical adjustment range
- Supports monitors up to 7kg
- 75mm and 100mm VESA compatible fixing plate
- 360° monitor and arm rotation
- Maximum size of monitor is 24"

Model Number:
WTMA523LC

Design Origin: America

LEADTIME: 6 – 8 weeks

Manufacturing Location: Dongguan, China



IV. WORK SUPPORT SPACES

CHINA | WORKTOOLS | DUAL MONITOR ARM – VOLLEY (DESK CLAMP)

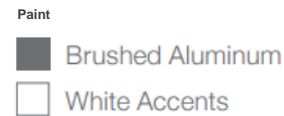


Image for visual purpose only

ABOUT THE SOLUTION

- 240mm minimum vertical adjustment range
- Supports monitors up to 7kg
- 75mm and 100mm VESA compatible fixing plate
- 360° monitor and arm rotation
- Maximum size of monitor is 24"

Model Number:
WTMA723

Design Origin: America

LEADTIME: 6 – 8 weeks

Manufacturing Location: Dongguan, China



IV. WORK SUPPORT SPACES

CHINA | WORKTOOLS | DUAL MONITOR ARM – VOLLEY (LEXICON C-CLAMP)

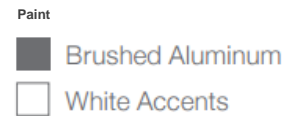


Image for visual purpose only

ABOUT THE SOLUTION

- 240mm minimum vertical adjustment range
- Supports monitors up to 7kg
- 75mm and 100mm VESA compatible fixing plate
- 360° monitor and arm rotation
- Maximum size of monitor is 24"

Model Number:
WTMA723LC

Design Origin: America

LEADTIME: 6 – 8 weeks

Manufacturing Location: Dongguan, China



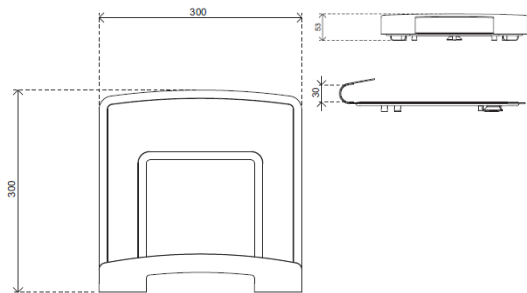
IV. WORK SUPPORT SPACES

CHINA | WORKTOOLS | NOTEBOOK HOLDER



Image for visual purpose only

PLAN VIEW



ABOUT THE SOLUTION

- 300W 53D 300H
- Able to hold 1 laptop only
- Supports a max, thickness of 30mm for an opened notebook
- Only available on white color

Design Origin: Asia Pacific

Note: Price excluded monitor arm, must order together with monitor arm for notebook holder.

Model Number:

C48271-NOTEBHOLDER

LEADTIME: 6 – 8 weeks

Manufacturing Location: Dongguan, China

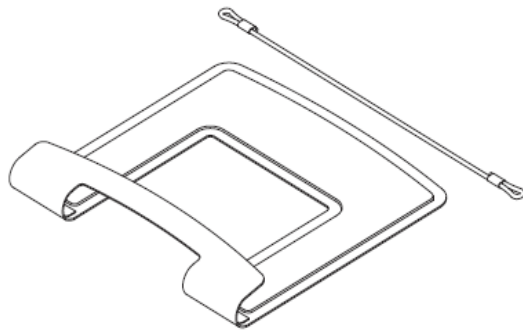
Notebook Holder - Features

WORKTOOLS

Suitable for almost every notebook. The elastic band holds your notebook securely in place so you can move it to your ideal position, including for example aligning it with your secondary display monitor. Due to its quick release mounting head you can switch easily between your notebook holder and other worktools.

Features

- Very fast installation
- VESA mount rotation block enabled by default
- Exclusively compatible with AP worktools with quick-release VESA system
- Supports a max. thickness of 30mm for an opened notebook
- Hidden cable management is easily accessible
- Fitted with protective non-slip foam
- Includes elastic safety band





IV. WORK SUPPORT SPACES

CHINA | WORKTOOLS | MARKERBOARD



Image for visual purpose only

ABOUT THE SOLUTION

- 390W 270H
- With magnet sheet
- Melamine laminate surface that guards against marker ghosting
- Integrated holder for dry erase markers

Model Number:
LA04PMBP

Design Origin: America

LEADTIME: 6 – 8 weeks

Manufacturing Location: Dongguan, China



V. WORK SUPPORT SPACES

CHINA | WORKTOOLS | NAMETAG

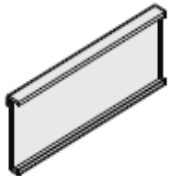


Paint



Image for visual purpose only

PLAN VIEW



ABOUT THE SOLUTION

- 200W 60H

Model Number:

LANTAG150

Design Origin: America

LEADTIME: 6 – 8 weeks

Manufacturing Location: Dongguan, China

Support Spaces

- Canteen
- Reception Area
- Pantry



IV. Support Spaces

Canteen



TABLE & CHAIR
Lexicon (Rectangular) +
Backliner



TABLE
Lexicon (Square) + Backliner



TABLE
Lexicon Social Round

Reception Area



LOUNGE SETTING
Campfire Lounge

Pantry



LOUNGE SETTING
B Free Lounge



STOOL CHAIR
Scoop



ACTIVE CHAIR
Buoy

How to classify selection

Each Support space configuration shown above is divided into different setting:

- CANTEEN
- RECEPTION
- PANTRY



IV. SUPPORT SPACES

CHINA | CANTEEN – LEXICON SOCIAL TABLE (RECTANGULAR) AND BACKLINER CHAIR



Image for visual purpose only

Laminate Desk & Table



Paint All Tables



Seating Frame / Base / Leg color All Seating



ABOUT THE SOLUTION

A. Backliner Chair

B. Lexicon Social Table (Rectangular) – 1600W 900D 720H

Product Environmental Certifications



Model Number:

C48006-LXSTS160807
BCKL100004

Design Origin: Asia Pacific & America

LEADTIME: 6 – 8 weeks

Manufacturing Location: Dongguan, China



IV. SUPPORT SPACES

CHINA | CANTEEN – LEXICON SOCIAL TABLE (SQUARE) AND BACKLINER CHAIR



Image for visual purpose only

Laminate
 Desk & Table



Paint
 All Tables



Seating Frame / Base / Leg color
 All Seating



ABOUT THE SOLUTION

- A. Backliner Chair
- B. Lexicon Social Table (Square) – 900W 900D 720H

Product Environmental Certifications



Model Number:

LXSTS080807
 BCKL100004

Design Origin: Asia Pacific & America

LEADTIME: 6 – 8 weeks

Manufacturing Location: Dongguan, China



IV. SUPPORT SPACES

CHINA | CANTEEN – LEXICON SOCIAL TABLE - ROUND



Image for visual purpose only

Laminate Desk & Table



Paint All Tables



Seating Frame / Base / Leg color All Seating



ABOUT THE SOLUTION

Lexicon Social Table Round
800DIA 720H

Product Environmental Certifications



Model Number:

LXSTR1007
BCKL100004

Design Origin: Asia Pacific

LEADTIME: 6 – 8 weeks

Manufacturing Location: Dongguan, China



IV. SUPPORT SPACES

CHINA | BACK LINER CHAIR – FOR CANTEEN OR TRAINING

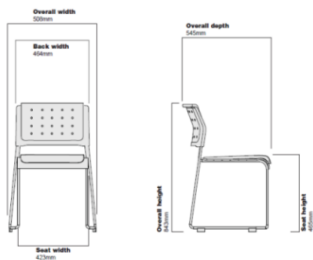


Image for visual purpose only

Seating Frame / Base / Leg color
 All Seating



PLAN VIEW



ABOUT THE SOLUTION

- Backliner Chair
- Stackable
- Stacks 20 high on a storage dolly
- Stacks 8 high on the floor
- Seat shell : plastic
- Tripod base : plastic
- Swivel seat
- Hard casters



MM: 04-1252090

Product Environmental Certifications



Model Number:

BCKL100004

Design Origin: America

LEADTIME: 6 – 8 weeks

Manufacturing Location: Dongguan, China



IV. SUPPORT SPACES

CHINA | RECEPTION AREA | CAMPFIRE LOUNGE SETTINGS



Image for visual purpose only

Fabric for Workstation Screen – Buzz2

Fabric Covered Panel Skins, Bench Centered Screen & Side Screen



Paint

All Tables



Seating Frame / Base / Leg color

All Seating



BK : Black

ABOUT THE SOLUTION

- A. Campfire Lounge (without Big Lamp)
- B. Campfire round paper table
- C. Personal Table
- D. Ottoman
- E. Campfire Screen

Product Environmental Certifications



Model Number:

- CF3BC
- CF34401
- CF4TPT
- CF4TWP
- CF4TSCRNR

Design Origin: America

LEADTIME: 6 – 8 weeks

Manufacturing Location: Puchong, Malaysia



IV. SUPPORT SPACES

CHINA | PANTRY AREA | B FREE LOUNGE SETTING

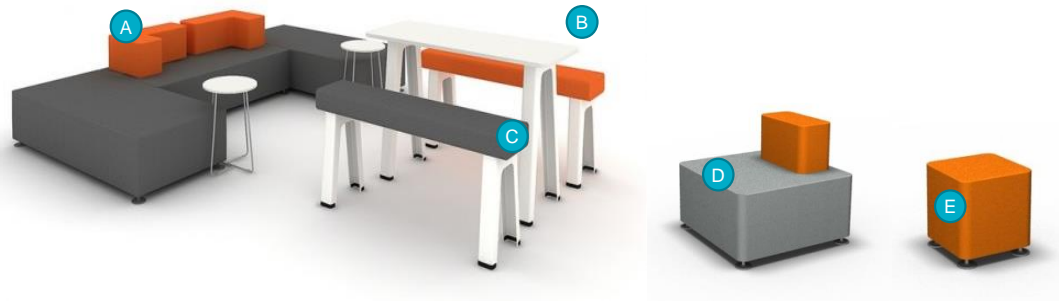


Image for visual purpose only

Laminate Desk & Table



Fabric- Buzz2



Paint All Tables



ABOUT THE SOLUTION

- A. Bfree Block, L Block
- B. Bfree Table
- C. Bfree Lounge Beam
- D. Bfree Block, I Block
- E. Bfree Cube

Product Environmental Certifications



Model Number:

BFL000030
 BFL100010
 BFL300010
 BFL300170
 BFL300050

Design Origin: Europe

LEADTIME: 6 – 8 weeks

Manufacturing Location: Puchong, Malaysia



IV. SUPPORT SPACES

CHINA | PANTRY AREA | SCOOP STOOL

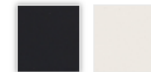


Image for visual purpose only

Fabric – Buzz2



SEAT COLOR *



ABOUT THE SOLUTION

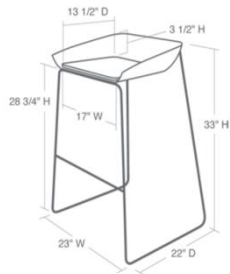
- Scoop Stool
- With cushion

Product Environmental Certifications



Model Number:

TS30702



Design Origin: America

LEADTIME: 12 – 14 weeks

Manufacturing Location: Americas



IV. SUPPORT SPACES

CHINA | PANTRY AREA | BUOY



Buoy Canister Color (Body)



Fabric– Buzz2



Image for visual purpose only

ABOUT THE SOLUTION

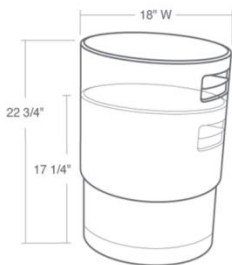
- Buoy
- 18" diameter upholstered cap – available in 25 fabrics to add color to your spac.
- Pneumatic cylinder height adjustment – 5 1/2" range to fit all sizes
- Curved base – rocks to encourage active sitting
- Built-in handle – used to adjust height and easier to carry

Product Environmental Certifications



Model Number:

TSBUOYWHITE



Design Origin: Americas

LEADTIME: 12 – 14 weeks

Manufacturing Location: Americas



BUOY
ACTIVE CHAIR

Product Information Packet

Buoy - Features

SEATING

With six bold colors, and endless ways to personalize, Buoy™ is a moving experience. Sitting. It's only the beginning.

Why choose Buoy?

After researching multiple small businesses, we noticed something: people are mobile, even when seated. Whether you're a knee bouncer, a pencil tapper, or you've got jazz hands, Buoy lets you move freely. So feel free to pull up a seat. Or lean in. Or hunker down. Mobility matters.

Key Features

- Well-adjusted | Size doesn't matter—Buoy was designed for everyone. Which is why Buoy provides five and a half inches of height adjustability with the lift of a lever. Plus, a curved base encourages active sitting.
- Mobile design | With a built-in handle and weighing only 20 pounds, Buoy is designed to go wherever you go. Got a touchdown meeting to attend? Want to focus on your thesis? At work, at home, or anywhere in between, Buoy gets around.
- Anyone, anytime, anywhere | The day doesn't stop at five o'clock, and neither does Buoy. Designed to be a part of people's active lifestyle, Buoy is as comfortable at home as it is in the classroom and the office. Or anywhere else people sit, for that matter.

Certifications

Certifications can help you choose products that are environmentally sustainable and just right for your project. B-Free has achieved the following certifications:

- ANSI/BIFMA e3-2014e
- SCS Indoor Air Quality Gold

Product Data

Additional Product Information:

<https://www.steelcase.com/products/collaborative-chairs/buoy/>



Task & Visitor Seating

- Low
- Medium
- High
- Premium
- Exclusive



V. Task & Visitor Seating

Task Chair



LOW
Personality Chair



MID
Reply Chair



HIGH
Think Chair



PREMIUM
Leap Chair



EXCLUSIVE
Gesture Chair

Visitor Chair



LOW
Think Sled



MID
Reply 4 Legs



HIGH
Reply Sled



PREMIUM
Think 4 star base

Each chairs shown above is divided into different ranks based on its price:

- **LOW** – most cost effective
- **MID** – above average to low
- **HIGH** – slightly higher than average cost
- **PREMIUM** – expensive



V. TASK AND VISITOR SEATING

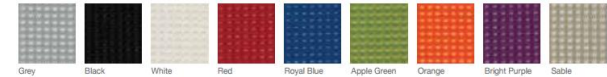
CHINA | TASK CHAIR | LOW PRICE - PERSONALITY CHAIR



Image for visual purpose only

Seating – Air Mesh

Personality, Reply



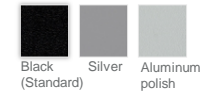
Seating – Group Omni-R

All Seating



Seating Frame / Base / Leg color

All Seating



Leg Color: Pricing provided is standard black.

Note: Finishes price varies by fabric group and colors.

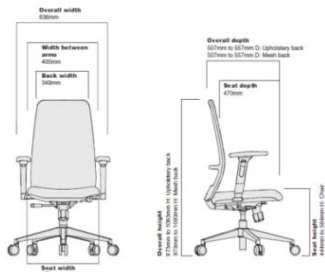
All other color mix will be subjected to additional cost.

Fabric price group 1 – No cost

Fabric price group 2 – Additional cost

Frame/Base/leg outside of standard will have additional cost.

PLAN VIEW



ABOUT THE SOLUTION

- Personality mesh
- Synchro-tilt mechanism
- Five-star base
- Casters 65mm
- Adjustable Arms 65mm
- Adjustable Seat Height
- Arm caps pivot 5 degrees inwards & 15 degrees outward

- Arm depth can retract 40mm
- Seat depth adjust within 50mm
- Tilt tension
- Coat hanger or headrest are available

Headrest Option Available

(with additional cost).



Product Environmental Certifications



Model Number:

PVT111111

Design Origin: Asia Pacific

LEADTIME: 6 – 8 weeks

Manufacturing Location: Dongguan, China

Personality Chair - Features

Personality combines outstanding ergonomic support with intuitive adjustability to enable each user to adjust the position of comfort to suit their physique and the task in hand. The mesh backrest distributes weight to minimize pressure on the spine while reclining, as well as providing excellent air circulation for thermal comfort.



1 Cool soft mesh
Airy and light, the mesh is soft to the touch and automatically adjusts to support each users' spinal print



2 Lumbar support
Optional in Mesh versions, grab the handle and slide the height adjustable lumbar support to customize the added lower back support.



3 Armrest
The height, pivot and depth adjustable arms enables individual users to tailor comfortable support for different tasks.



4 Adjustable seat depth
Seat depth adjusts to accommodate different leg lengths, providing individual users with comfortable ergonomic support.



5 Seat Comfort
The seat is amazingly comfortable thanks to advanced adaptive bolstering techniques with the foam.



6 Hook
A convenient hook for hanging and keeping close small personal items is default on all versions.



7 Jacket hanger
Optional jacket hanger allows users to keep jackets handy and wrinkly free, all while saving closet space.



Back belt
The Upholstered version has a storage belt, allowing for quick access to tools and personal items.



Headrest
Optional headrest helps to keep the head and neck supported in both upright or reclined positions.



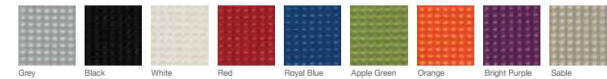
V. TASK AND VISITOR SEATING

CHINA | TASK CHAIR | MEDIUM PRICE - REPLY CHAIR



Image for visual purpose only

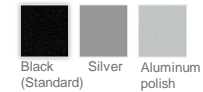
Seating – Air Mesh
 Personality, Reply



Seating – Group Omni-R
 All Seating



Seating Frame / Base / Leg color
 All Seating



Leg Color: Pricing provided is standard black.

Note: Finishes price varies by fabric group and colors.
 Fabric price group 1 – No cost
 Fabric price group 2 – Additional cost
 Frame/Base/leg outside of standard will have additional cost.

All other color mix will be subjected to additional cost.

PLAN VIEW



ABOUT THE SOLUTION

- Reply Air Task Chair – Mesh Back (without adjustable lumbar support)
- Seat height adjusts within a 127mm range with a pneumatic adjustment mechanism
- Arm cap can pivot independently 18degree in and 4degree
- Multi-position back lock allows user to recline.
- Tilt tension adjustments.
- Arm height can adjust independently within 96mm range to help relieve upper back and shoulder fatigue

Design Origin: America

Product Environmental Certifications



Model Number:

RPY-12111

LEADTIME: 6 – 8 weeks

Manufacturing Location: Dongguan, China

Reply® Chair - Features

A global family of seating. Work happens in many places. Choices for seating are abundant with Reply® — a complete global family of chairs that are as nice to look at as they are to sit in.





V. TASK AND VISITOR SEATING

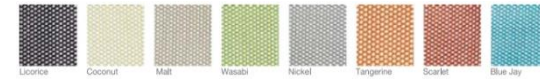
CHINA | TASK CHAIR | HIGH PRICE - THINK CHAIR



Image for visual purpose only

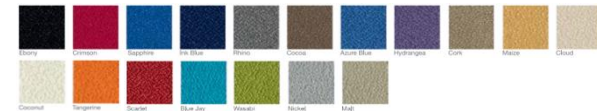
Seating – 3D knit

Gesture, Leap, Think, Think Visitor



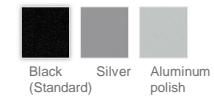
Seating – Group Omni-R

All Seating



Seating Frame / Base / Leg color

All Seating



Leather Options available

(Additional cost)

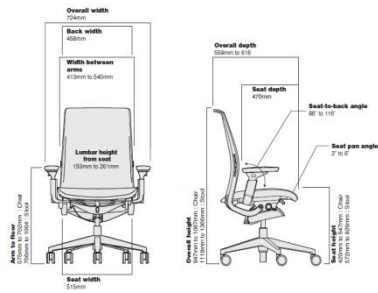


Note: Finishes price varies by fabric group and colors.
 Fabric price group 1 – No cost
 Fabric price group 2 – Additional cost
 Frame/Base/leg outside of standard will have additional cost.

Leg Color: Pricing provided is standard black.

All other color mix will be subjected to additional cost.

PLAN VIEW



ABOUT THE SOLUTION

- Think
- Integrated LiveBack System
- Advanced weight-activated mechanism
- Comfort dial back control
- Adjustable arms
- Arm caps can pivot 30°
- Casters
- Adjustable Seat Height within 127mm
- Arm width adjusts 115mm

- Adjustable Seat Height within 127mm
- Arm width adjusts 115mm
- Arm height can adjust independently within 102mm
- Arm depth can retract 77mm
- Passive seat edge angle
- Lumbar height adjustment

Product Environmental Certifications



Headrest Option Available

(with additional cost).



Model Number:

465A300

Design Origin: America

LEADTIME: 6 – 8 weeks

Manufacturing Location: Dongguan, China

Think® Chair - Features

The Think chair is an ergonomic office chair that senses what your body needs. The Integrated LiveBack™ System conforms to your body and moves with you as you change postures. It features an advanced weight-activated seat, so anybody can get comfortable, quickly.

INTEGRATED LIVEBACK SYSTEM

Back Flexors track with the natural shape of your spine, and are linked together to provide integrate and prescribed movement.

DUAL-ENERGY LUMBAR

Dual-Energy Lumbar uses embedded spring energy to provide responsive lumbar support as you change postures.

SEAT DEPTH

Allows the seat to be positioned forward or backward to achieve long-term comfort.

COMFORT DIAL

Allows users to quickly adjust to one of these four comfort settings:

- Upright back lock
- Mid-stop recline
- Full recline with weight-activated tension + 20% boost
- Full recline with weight-activated tension

ADJUSTABLE ARMS

Adjustable arms move in four directions for personalized arm support: height, width, pivot and depth.

ADAPTIVE BOLSTERING

Adaptive bolstering in the seat cushion allows the the seat to conform to your shape, providing dynamic support that can adapt to your body as you change postures.

FLEXIBLE SEAT EDGE

Flexible seat edge flexes down to relieve pressure on the back of the legs.





V. TASK AND VISITOR SEATING

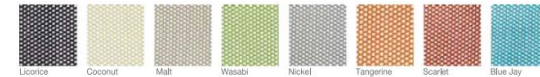
CHINA | TASK CHAIR | PREMIUM PRICE - LEAP CHAIR



Image for visual purpose only

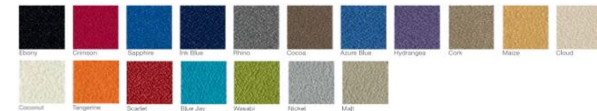
Seating – 3D knit

Gesture, Leap, Think, Think Visitor



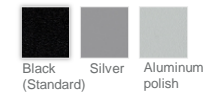
Seating – Group Omni-R

All Seating



Seating Frame / Base / Leg color

All Seating



Leather Options available

(Additional cost)

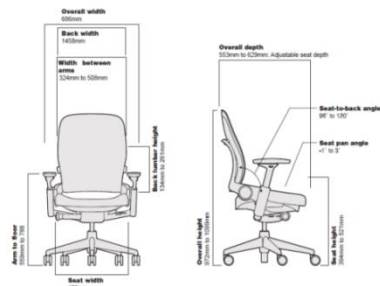


Note: Finishes price varies by fabric group and colors.
 Fabric price group 1 – No cost
 Fabric price group 2 – Additional cost
 Frame/Base/leg outside of standard will have additional cost.

Leg Color: Pricing provided is standard black.

All other color mix will be subjected to additional cost.

PLAN VIEW



ABOUT THE SOLUTION

- Leap (Back: 3D Knit; Seat: Fabric)
- Outer back and outer seat are plastic
- Integrated LiveBack System
- Rectilinear arms
- Lumbar height adjusts 127mm
- Casters
- Arm depth can retract 77mm
- Arm width can adjust 115mm overall

- Arm caps can pivot 30°
- Lumbar height adjusts 127mm
- Passive seat edge
- Variable back stop
- Seat height adjusts with in a 127mm range

Product Environmental Certifications



Headrest Option Available

(with additional cost).



Model Number:

LEAP-11100

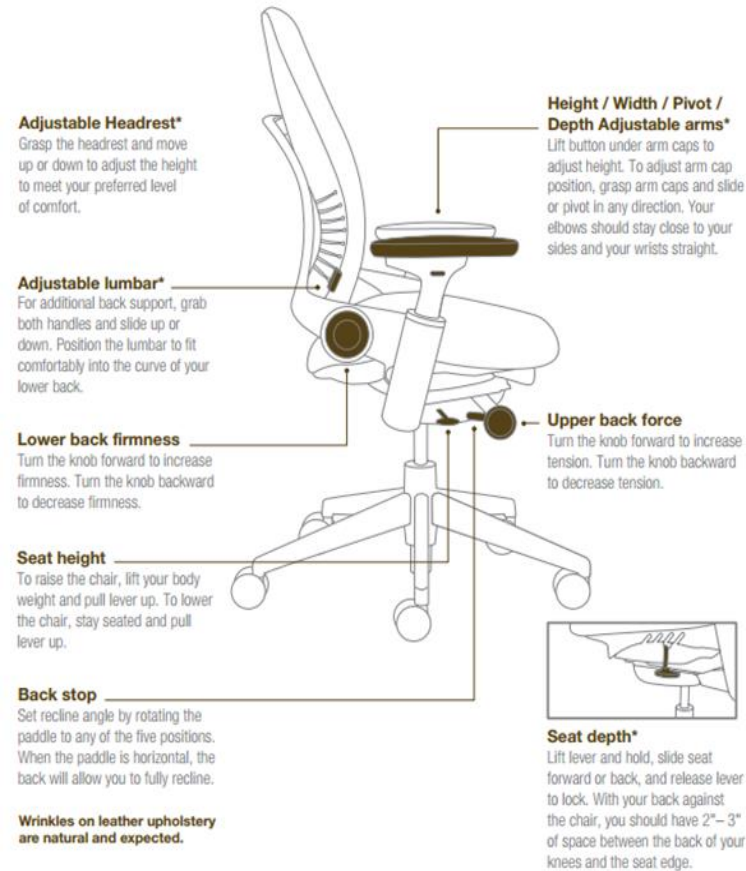
LEADTIME: 6 – 8 weeks

Manufacturing Location: Dongguan, China

Design Origin: America

Leap® Chair - Features

Its back moves as your back moves. Its arms move as your arms move. Its seat moves as your seat moves. It's the first chair that actually changes shape to mimic and support the movement of your spine. Thanks to its advanced technology and extraordinary comfort, the Leap chair is a proven technology... a healthier way to sit.



LiveBack*
 Changes shape to mimic the movement of the spine.



Adjustable Seat Depth
 Accommodates to ensure long term comfort.



Adjustable Seat Height
 Adjusts to fit various heights.



Adjustable Lumbar
 Fits the curve of your lower back for additional support.



Lower Back Firmness
 Provides constant support to your lower back.



Upper Back Force
 Controls the precise amount of "push back" as you recline.



Variable Back Stop
 Sets the angle of recline to one of five positions.



Adjustable Arms
 Keep your arms, shoulders and neck properly aligned.



V. TASK AND VISITOR SEATING

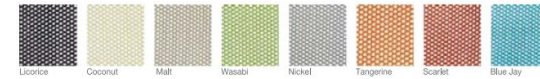
CHINA | TASK CHAIR | EXCLUSIVE PRICE - GESTURE CHAIR



Image for visual purpose only

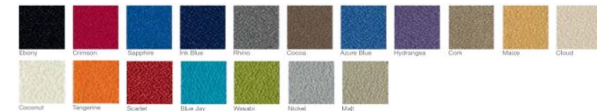
Seating – 3D knit

Gesture, Leap, Think, Think Visitor



Seating – Group Omni-R

All Seating



Seating Frame / Base / Leg color

All Seating



Leather Options available

(Additional cost)

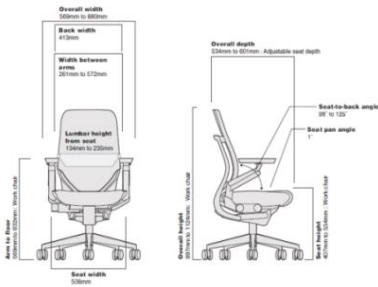


Note: Finishes price varies by fabric group and colors.
 Fabric price group 1 – No cost
 Fabric price group 2 – Additional cost
 Frame/Base/leg outside of standard will have additional cost.

Leg Color: Pricing provided is standard black.

All other color mix will be subjected to additional cost.

PLAN VIEW



ABOUT THE SOLUTION

- Gesture Shell back (Back: 3D Knit; Seat: Fabric)
- 3D LiveBack + 4D Arms
- Core equalizer
- Rectilinear arms with soft caps
- Casters
- Back frame, back shell, seat perimeter, arms and base are standard in black schemes
- Variable back stop with 4 positions
- Back tension
- Pneumatic adjustment mechanism
- Wrapped upper back upholstery design
- 360° arm enables 360° of motion to give arm support
- Soft arm caps
- Passive seat edge
- Lumbar height adjustment

Product Environmental Certifications



Model Number:
442A30

Design Origin: America

LEADTIME: 6 – 8 weeks

Manufacturing Location: Dongguan, China

Gesture™ Chair - Features

Gesture™ is the first office chair designed to support a greater range of technologies, postures and user sizes. Inspired by the human body, designed for the way we work today.

360 Arm - Armrest height, depth, width and pivot



Height adjustable lumbar support

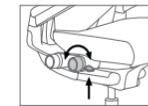


Seat depth adjustment

Back tension with Variable Back Stop

Seat height adjustment

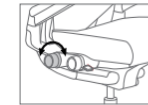
GESTURE CONTROLS



USER INTERFACE

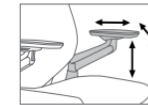
Seat Depth – To extend seat depth, remain seated and turn knob away from you. To retract, remain seated and turn knob toward you.

Seat height – To raise chair, lift your body weight and hold lever up. To lower chair, remain seated and hold lever up.



Back tension – Allows you to adjust the force required to sit upright or recline. Turn the knob forward for more resistance and backward for less resistance.

Variable Back Stop – This dial is located inset of the back tension knob. It allows four settings: upright lock, full recline, and two stops in between.



LIMB INTERFACE

360 Arm – A single release enables 360 degrees of motion, giving arm support wherever needed.

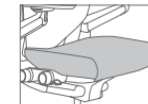
To adjust arm cap position, grasp arm caps and slide in any direction.



CORE INTERFACE

3D LiveBack™ – Provides sagittal, lateral, and torsional movement while maintaining persistent support.

Core Equalizer – Connects the seat to the back so they move together and provides just the right amount of lumbar support in any angle of recline.

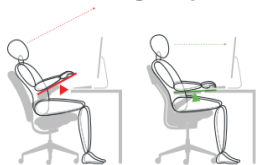


SEAT INTERFACE

Flexible edges – Designed with soft edges, comfort is extended to the edge of the seat.

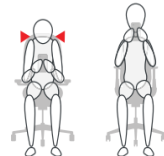
Adaptive bolstering – The Gesture seat is designed with air pockets carefully placed beneath the foam to give consistent comfort to a range of users.

Greater range of posture support and user sizes



SUPPORTING HEALTHY MOVEMENT

Gesture allows healthy movement and postures like reclining without pulling users away from their work.



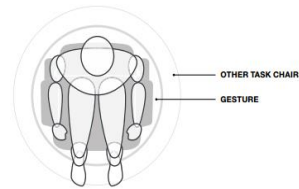
SUPPORTING MOBILE TECHNOLOGY

Gesture's supportive design helps prevent tech neck—an increasing health issue in the workplace. Highly adjustable arms enable users to bring small mobile devices in close and up to eye level, avoiding awkward and unhealthy postures.



SUPPORTING THE LOWER BACK

Gesture conforms to a user's back, preventing unhealthy postures that result from a lower back gap.



OTHER TASK CHAIRS
 GESTURE



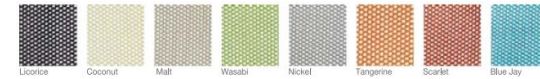
V. TASK AND VISITOR SEATING

CHINA | VISITOR CHAIR | LOW PRICE - THINK SLED

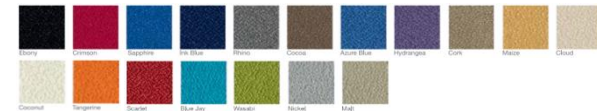


Image for visual purpose only

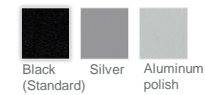
Seating – 3D knit
 Gesture, Leap, Think, Think Visitor



Seating – Group Omni-R
 All Seating

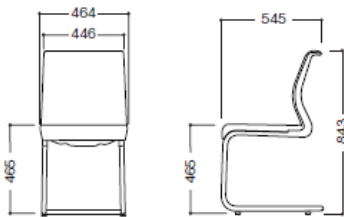


Seating Frame / Base / Leg color
 All Seating



Leg Color: Pricing provided is standard black. Note: Finishes price varies by fabric group and colors.
 All other color mix will be subjected to additional cost. Fabric price group 1 – No cost
 Frame/Base/leg outside of standard will have additional cost. Fabric price group 2 – Additional cost.

PLAN VIEW



ABOUT THE SOLUTION

- Think Sled base
- Armless
- Sled Base
- 3D knit on back
- Standard upholstery on seat
- Frame and seat shell are black
- Glides : hard, plastic

Product Environmental Certifications



Model Number:

465D300

Design Origin: America

LEADTIME: 6 – 8 weeks

Manufacturing Location: Dongguan, China



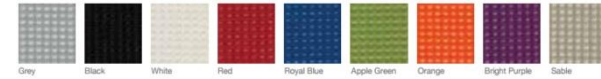
V. TASK AND VISITOR SEATING

CHINA | VISITOR CHAIR | MID PRICE - REPLY 4 LEGS

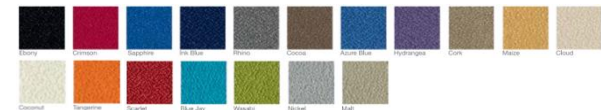


Image for visual purpose only

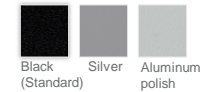
Seating – Air Mesh
 Personality, Reply



Seating – Group Omni-R
 All Seating

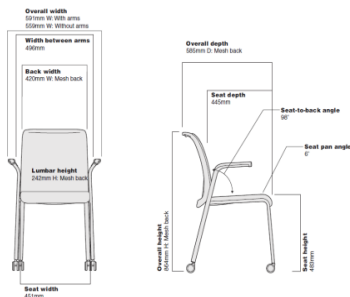


Seating Frame / Base / Leg color
 All Seating



Leg Color: Pricing provided is standard black. Note: Finishes price varies by fabric group and colors.
 All other color mix will be subjected to additional cost. Fabric price group 1 – No cost
 Frame/Base/leg outside of standard will have additional cost. Fabric price group 2 – Additional cost

PLAN VIEW



ABOUT THE SOLUTION

- Reply 4 Legs
- Armless
- Mesh on back
- Frame : Paint
- Casters : Dual-wheel hard casters

Design Origin: America

Product Environmental Certifications



Model Number:

RPY-72000

LEADTIME: 6 – 8 weeks

Manufacturing Location: Dongguan, China



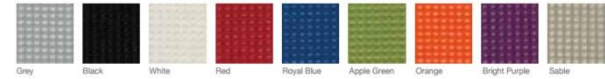
V. TASK AND VISITOR SEATING

CHINA | VISITOR CHAIR | HIGH PRICE- REPLY SLED

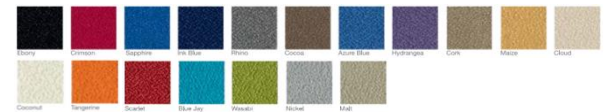


Image for visual purpose only

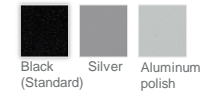
Seating – Air Mesh
 Personality, Reply



Seating – Group Omni-R
 All Seating

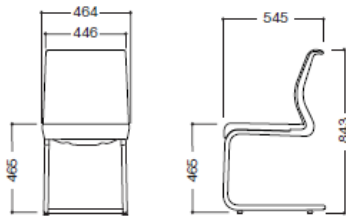


Seating Frame / Base / Leg color
 All Seating



Leg Color: Pricing provided is standard black. Note: Finishes price varies by fabric group and colors.
 All other color mix will be subjected to additional cost. Fabric price group 1 – No cost
 Frame/Base/leg outside of standard will have additional cost. Fabric price group 2 – Additional cost.

PLAN VIEW



ABOUT THE SOLUTION

- Reply Sled base
- Armless
- Mesh on back
- Frame : Paint
- Glides : Soft glides for use on hard floors

Product Environmental Certifications



Model Number:

RPY-42000

Design Origin: America

LEADTIME: 6 – 8 weeks

Manufacturing Location: Dongguan, China



V. TASK AND VISITOR SEATING

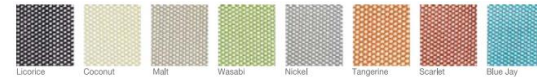
CHINA | VISITOR CHAIR | PREMIUM PRICE- THINK 4 STAR LEG



Image for visual purpose only

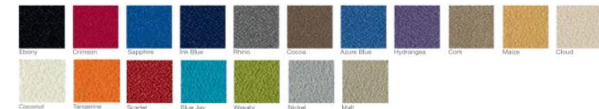
Seating – 3D knit

Gesture, Leap, Think, Think Visitor



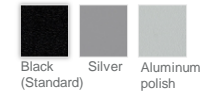
Seating – Group Omni-R

All Seating



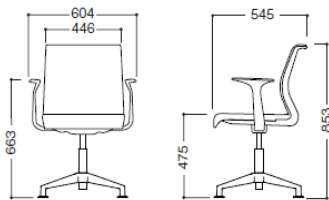
Seating Frame / Base / Leg color

All Seating



Leg Color: Pricing provided is standard black. Note: Finishes price varies by fabric group and colors.
 All other color mix will be subjected to additional cost. Fabric price group 1 – No cost
 Fabric price group 2 – Additional cost
 Frame/Base/leg outside of standard will have additional cost.

PLAN VIEW



ABOUT THE SOLUTION

- Think 4-star Leg
- Armless
- Four star base with automatic return
- Frame and seat shell : black
- Standard upholstery on back and seat
- 4 star base with auto return : black
- Glides : hard, plastic

Design Origin: America

Product Environmental Certifications



Model Number:

465C030

LEADTIME: 6 – 8 weeks

Manufacturing Location: Dongguan, China

Basic of Ergonomic Seating

A well-designed ergonomically advanced chair that allows a full range of healthy postures throughout the day and can contribute to worker wellness and productivity.

Neck is straight or slightly forward.

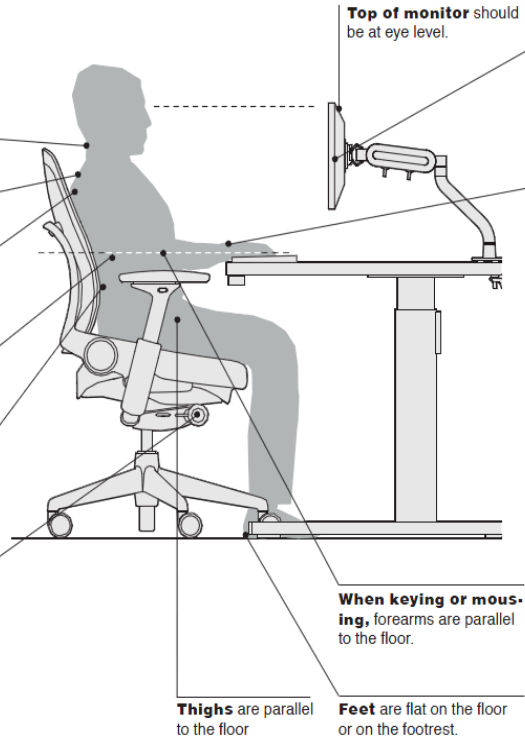
Shoulder are relaxed to arms hang naturally.

Back has full contact with the backrest (sit all the way back in your chair).

Elbows and forearms can rest comfortably on the arms of your chair, or on worksurfaces.

Lower back fits into curved lumbar support.

Tension is adjusted so backrest reclines easily, yet provides smooth, even support, and encourages postural change.



Top of monitor should be at eye level.

Screen is 508mm to 762mm from the eyes. Screen is at eye level slightly lower and directly in front of worker so head is not turned.

Wrists should be straight when keying or mousing, not bent up or down.

ANSI/BIFMA is the American National Standards Institute Business and Institutional Furniture Manufacturer's Association. All Steelcase furniture meets or exceeds ANSI/BIFMA standards for structural quality.

CAUTION

Regularly inspect for damaged or broken parts and loose fasteners (screws, etc). If any of these conditions exist, remove from service immediately. Repairs are to be made using only factory authorized parts and methods. Hard wheel casters must be used on carpeted surfaces only. Use on hard surfaces, including floor mats, will affect chair stability.

Failure to follow these instructions could result in property damage or personal injury.

Basic of Adjustability

Steelcase chairs offer varying levels of adjustability to meet the needs of many types of users. Adjustable seating may offer one or more of these features.

Mechanism



Advanced synchro-tilt allows the chair back and seat to move in a 2:8:8 ratio. As the user leans back the seat rises slightly to keep user's feet on the floor.



Weight-activated feature allows for an amount of recline resistance that is directly proportional to the user's weight.



Synchro-tilt feature means the chair back and seat are synchronized to move in a ratio. When the user leans back, the seat rises less, allowing the user's feet to remain flat on the floor.



Natural-glide feature causes the seat to slide forward as the user reclines keeping the user within his or her vision and reach zone.



Advanced swivel-tilt feature incorporated to remain level even when the user leans back.

Arm Adjustment



Arm height adjustment allows the user to move the arms up or down independently.



Arm width adjustment allows the user to move the arms in or out independently.



Arm pivot adjustment allows the user to position arm rests as appropriate for the task being performed.



Arm depth adjustment allows users to get closer to their work by chair arms moving out of the way.

Seat Adjustment



Pneumatic height adjustment allows the user to remain seated while adjusting the seat height by way of a control button or lever.



Seat depth adjustment allows the user to slide the seat forward or back.



Lumbar height affords additional lower back support. Grasp lumbar handles and slide up or down to adjust.



Lower back firmness changes the amount of firmness user feels in lower back.



Your Preference back control includes four settings - weight-activated, boosted, mid-stop, and upright - that allow for personal preference and work styles.



Headrest adjustment allows the user to support head and neck in upright or reclined posture.



Multi-position back lock allows users to recline the back to the desired angle and lock it in place.



Core equalizer connects the back and the seat to the advanced synchro-tilt and allows appropriate amount of lumbar support in any angle of recline.



Passive seat edge angle allows front edge of seat to drop down while seat angle remains unchanged.



Back tension adjustment allows the user to control the amount of resistance felt when leaning back in the chair.



Upper back tension feature provides an increasing amount of force that increases as the user reclines.



Upright back lock allows the user to lock the backrest in a full upright position or release it for full recline.



Variable back stop allows the user to lock the back upright, or to preset the range of recline.



Back height adjustment allows the user to raise or lower the chair back.

Other Features



Foot ring height can be adjusted up or down for user comfort. Cannot be done from seated position.

Overall Chairs Adjustability Features

Steelcase chairs offer varying levels of adjustability to meet the needs of many types of users. Adjustable seating may offer one or more of these features.

Work Chair Adjustability Features									
	Gesture	Leap	New Think	Think	Reply	Let's B	Personality	APT-S	APT-V
Mechanism									
Natural glide		•							
Weight activated			•	•					
Synchro-tilt	•		•		•	•	•	•	
Advanced swivel-tilt									•
Seat Adjustment									
Pneumatic height	•	•	•	•	•	•	•	•	•
Passive seat edge angle	•	•	•	•					
Seat depth	•	•	•	•	•	•	•	•	
Back Adjustment									
Lumbar height	•	•	•	•	•		• mesh type		
Lower back firmness		•							
Upper back tension		•							
Back tension	•				•	•	•	•	•
Variable back stop	•	•							
Your preference back control			•	•					
Upright back lock	•	•	•	•	•	•	•		
Variable back lock					•	•		•	•
Back height						•		•	

Overall Chairs Adjustability Features

Steelcase chairs offer varying levels of adjustability to meet the needs of many types of users. Adjustable seating may offer one or more of these features.

Work Chair Adjustability Features									
	Gesture	Leap	New Think	Think	Reply	Let's B	Personality	APT-S	APT-V
Arm Adjustment									
Arm height	•	•	•	•	•	•	•	•	
Arm width	•	•	•	•					
Arm depth	•	•	•	•	•		•		
Arm pivot	•	•	•	•	•	•	•	•	
Other features									
Foot ring height (stool)			• stool type	• stool type			• stool type		• stool type
Headrest		•	•	•			•		
Soft roll-control caster	•	•	•	•	•	•	•		
* See product understanding pages for additional details									

Steelcase Capabilities

- Introduction
- Proposed Team & Milestones
- Direct & Dealer Locations
- Plant Location
- Shipping Lead Times
- Sustainability Information

VI. Corporate Capabilities

JUST THE FACTS

.....

No.1

Global Market Position

1912

Company Established

110,000+

Companies served

\$USD3.1 Billion

Annual revenue for Fiscal 2016

500+

Product lines

12,000+

Employees worldwide

650+

Dealers globally

SCS

New York Stock Exchange since
1998 IPO



As the global leader in furnishing workplace environments, we have a unique ability to satisfy the needs of our customers anywhere in the world, wherever they work. Our brands offer a comprehensive portfolio of products and services, all inspired by over 100 years of insight gained from serving the world's leading organizations.

Headquartered in Grand Rapids, Michigan, our global reach provides a broad context for understanding emerging issues and what it means to be a responsible corporate citizen. In a fast-changing world that's more interdependent every day, we provide insights, products and services that help people do their best work. Unlocking human promise is the fundamental principle on which our company was founded in 1912, and it remains our focus today.

Steelcase began as The Metal Office Furniture Company in Grand Rapids, Michigan. We received our first patent in 1914 for a steel wastebasket – a major innovation at a time when straw wastebaskets were a serious office fire hazard. That led to metal desks, and we've led the way with product and service innovations ever since.

Introduction

A ROBUST GLOBAL PRESENCE

Across borders, time zones and languages, our global network of capabilities – unmatched in our industry – gives us roots and reach to provide products to our customers all over the world.

CREATING A BETTER, MORE SUSTAINABLE WORLD

From environmental leadership to supporting diversity to strengthening communities to spearheading efforts to improve urban schools, we invest in helping people realize possibilities. Through our own efforts and collaboration with others, we're recognized as a company that creates social, economic and environmentally sustainable value.

As a global company, Steelcase is dedicated to creating relationships with diverse businesses. We promote cultural acceptance through:

- Fair recruiting and hiring processes
- Raising awareness among employees of diversity issues
- Creating partnerships with other companies that support diversity

Visit **Steelcase.com** for more information

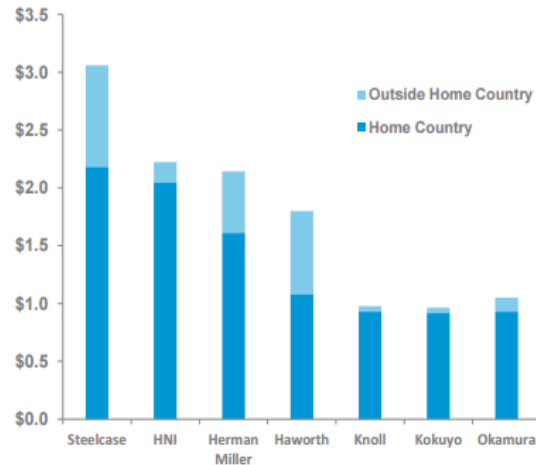
Our global capability is also our local differentiator

When compared to the sales volumes of firms considered to be our competitors, Steelcase's revenue base implies that we are the global leader in the commercial furniture market and have been for many years. Steelcase's global reach, extensive service capabilities, and broad product offering have uniquely allowed us to serve large customers with complex needs.

Following is the latest sales data from Steelcase and seven of our global competitors. The graph shows sales both within and outside the companies' home countries.

GLOBAL OFFICE FURNITURE MARKET SALES*

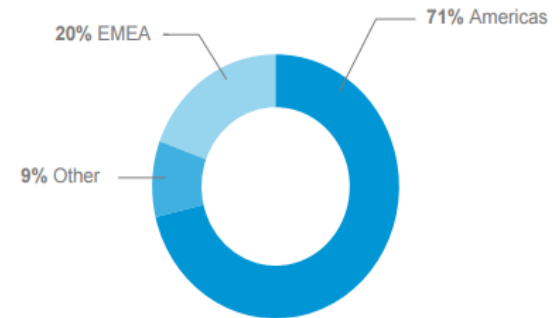
(\$ in billions)



*Most recently published annual data and/or internal estimates

BUSINESS SEGMENT REVENUE MIX*

(Steelcase Inc. - fiscal 2015)

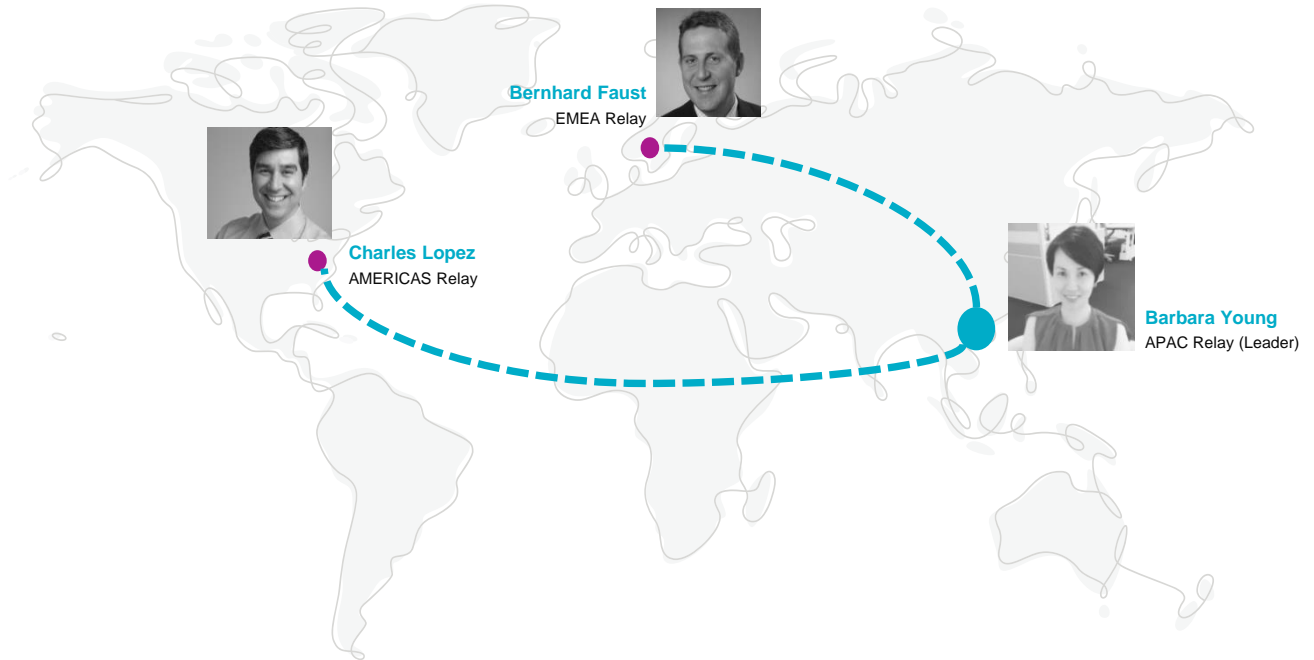


Proposed Global Team

Coordinated Global Efforts

Our global customers benefit from a dedicated network of Steelcase employees who are skilled at managing global projects, in the following topics:

- Collaborate with other locations.
- Create and manage your global project plans.
- Resolve issues.
- Manage global projects.
- Understand and communicate your needs.
- Assist with product application and design.
- Manage contracts and pricing.



Uli Gwinner
President Asia Pacific
Global Executive
Sponsor



Jason Taper
VP – AP Regional Sales, Global Client Collaboration
Global Account Owner
Asia Pacific

Huawei Account Relays

Global Leader

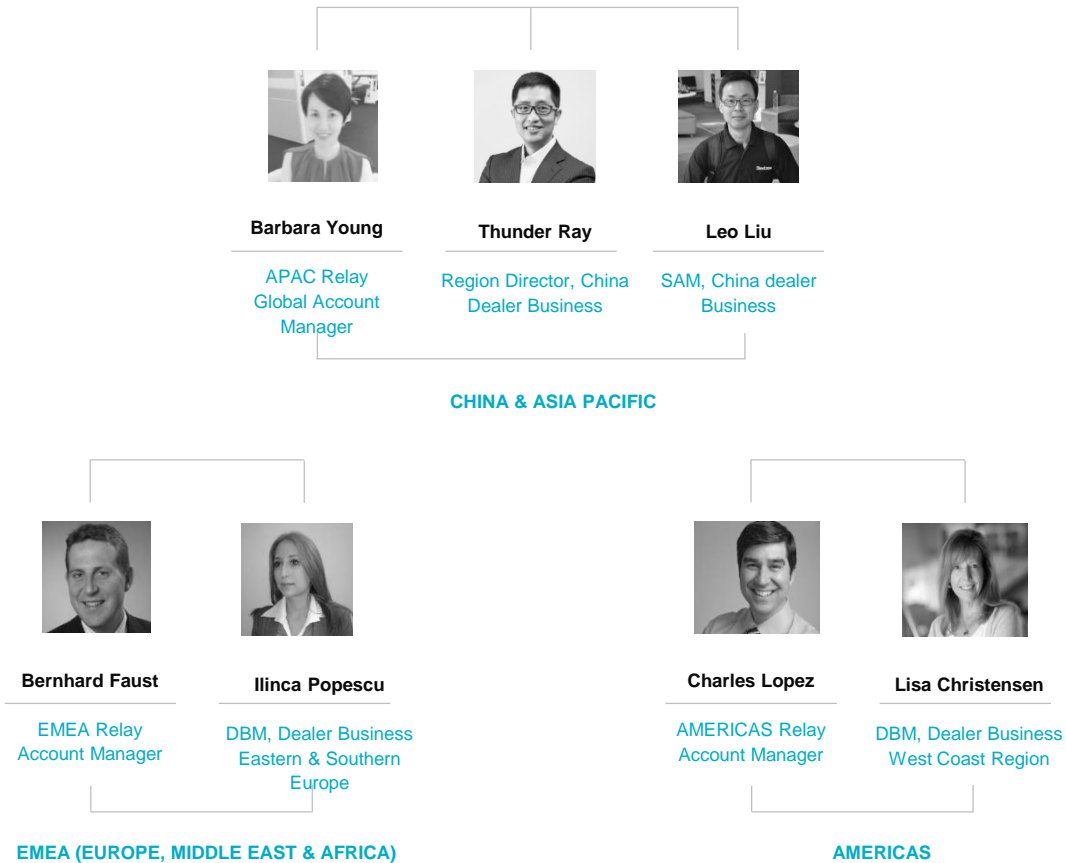
- Understands global needs
- Builds global account plan
- Manages global team
- Global communications
- Global relationship
- Global execution

Regional Relay

- Understands regional needs
- Builds regional account plan
- Manages regional team
- Regional communications
- Regional relationship
- Regional execution

Local Relay

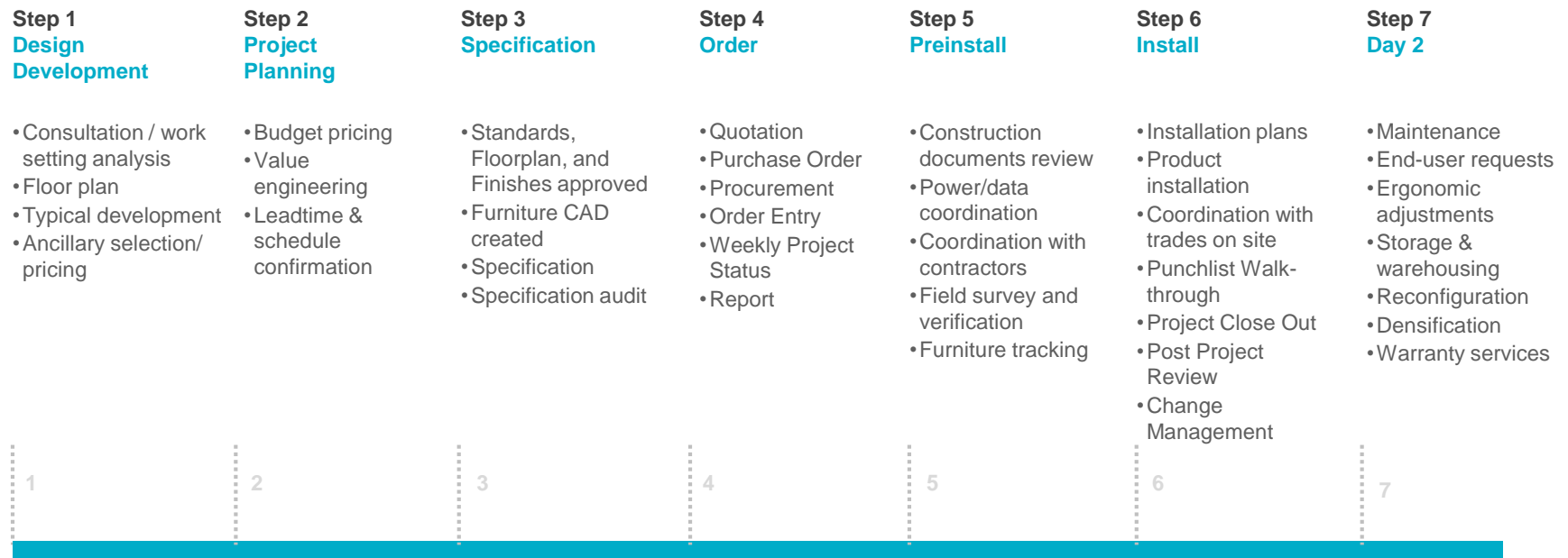
- Understands local needs
- Builds local account plan
- Manages local team
- Local communications
- Local relationship
- Local execution



Special Team + Milestones

SPECIAL TEAM

This table of milestones will be dedicated specifically to Huawei Technologies Globally with a team of specialist who will be allocated to, assist and monitor project highlights and progress, upon awarded. The added value service also includes reciting documents in **Chinese** globally. The special team will be led by **Barbara Young**, APAC Relay - Global Account Manager.



Capabilities + Innovation

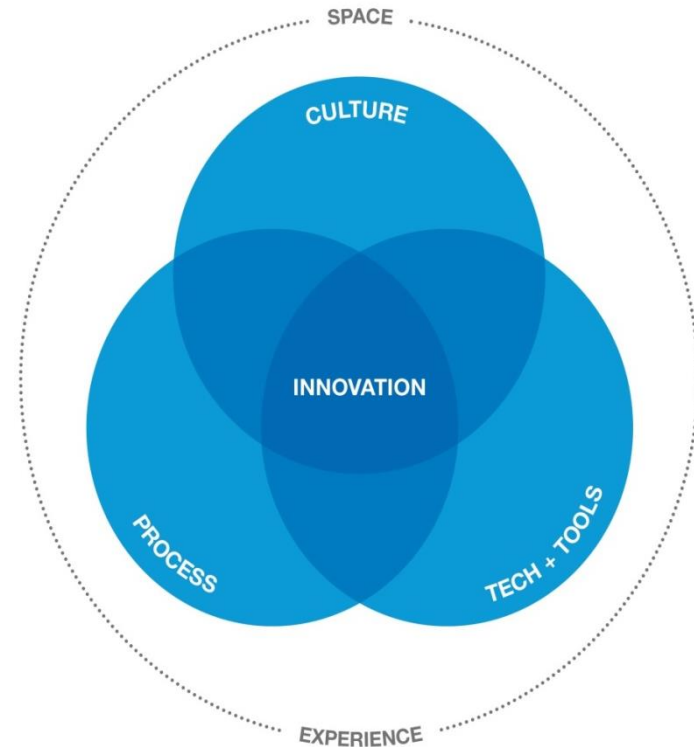
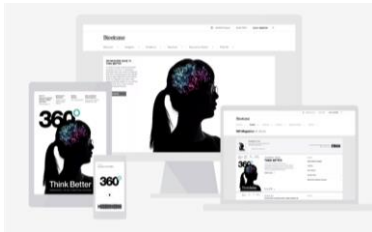
INNOVATION

The where of innovation, we believe...

- Culture influences innovation
- Process supports innovation
- Technology and tools accommodate innovation

We keep our knowledge current through the following means:

- Extensively researching projects on specific topics and industries
- Perpetually developing tools
- Publishing case studies, white papers, and our 360 magazine
- Constantly refining our research methodologies.

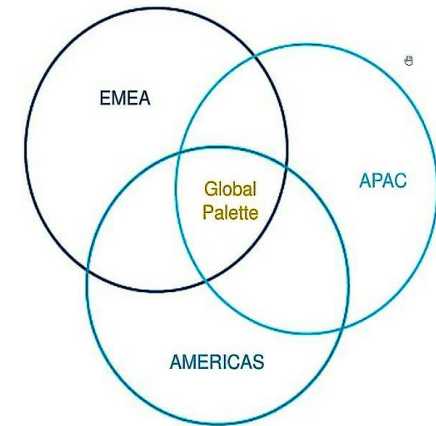


Design + Layout

WE CAN OFFER GLOBAL CONSISTENCY

Global companies are motivated by the desire to have a consistent representation of their culture and values across all geographies and internal branding plays an important role in corporate spaces. By working together in a series of structured sessions the Steelcase design team can offer Global consistency across the by delivering the right applications and solutions built based on local products & capabilities.

There's a noticeable trend for many leading organizations to better reflect and support their culture and brand across the globe. We can offer a Global Palette that is a core collection of finishes that help you represent your brand and culture across multiple geographies.



ASIA PACIFIC



EMEA



AMERICAS



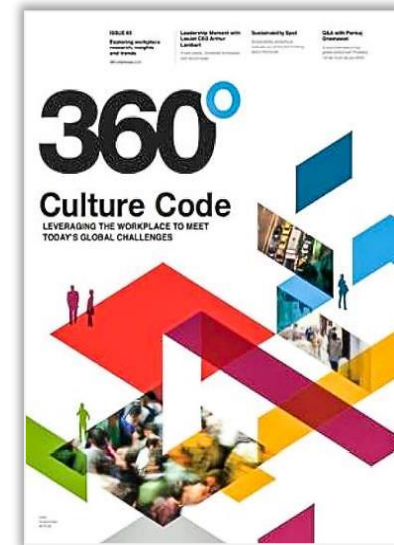
Design + Layout

CULTURE CODE

The Global applications Network uses our Culture Code insights to reflect and incorporate important values, employee behaviors and larger cultural contexts into work environments around the world. Through the lens of the Culture Code we gather insights and translate them into relevant applications.

Steelcase researchers released a study examining how local culture affects the work space. The results showed a space that is optimized for innovation and collaboration, encourages new ideas to flow and realize their potential. But an ideal configuration for Huawei Technologies China may not work the same way in Middle East, Africa, Europe and America. Design must take cultural traits into consideration.

We understand cultural similarities and differences between countries and we can create spaces which reflect the culture depending where the project is located.



Understanding Key Workplace Issues

Today's workplace must address the diverse ways people are working. It must support enhanced collaboration, the essence of knowledge work. It needs to inspire and attract people to work at the office instead of the coffee shop. It should nurture personal wellbeing, and leverage organizational culture and the company's brand. Overall, this workplace must make the most of every square inch of an organization's real estate.

Collaboration + Privacy

Collaboration is the way innovation is achieved. The workplace should enhance collaborative work whether it's face to face or distributed. The tools and spaces people required are very different from the past.

Attract, Develop And Engage

Hiring the right motivated workers is critical to success and innovation. Space can help attract the right talent and help workers develop the skills needed to work in an interconnected world.

Build Brand + Culture

You can't live your brand without living in your brand. It's about fostering the type of culture that fits your brand in an authentic way. Your space can match your values and be carried through the entire workplace to shape the behavior of employees.

Wellbeing @ Work

Wellbeing in the workplace needs to consider the whole person - the body and mind - and understand wellbeing is a systemic issue. Physical wellbeing impacts cognitive and emotional wellbeing. To have the brain fully firing, the body needs to be supported and comfortable.

Resilient Real Estate

Organizations are asking their real estate to work harder and smarter than ever before. Real estate optimization leverages the workplace to create greater value by supporting your people in new and innovative ways.

Workplace Workshop

DISCOVERY EXERCISE DISCUSSION

How are you leveraging the power of place?

Organizations strive to bring their people together with a shared purpose, in a workplace that delivers what users want and need. While this goal sounds simple, it can be difficult to articulate workplace priorities.

Aligning on workplace issues and priorities provides clarity for leaders and users. The Discovery Exercise allows audiences to identify and discuss workplace opportunities. Use the Discovery Exercise to:

- review the top issues affecting leading organizations
- prioritize and rank 16 workplace statements
- linking top workplace issues/priorities that have been collectively identified with business objectives

The Discovery Exercise discussion is implemented as an in-room exercise for a large, cross-functional group of participants. The experience is both informative and enlightening for the participants and leaders.

A discussion summary will be provided which includes high level space implications along with the identified Workplace Priorities.



Workplace Workshop

COLLABORATIVE SITUATIONS WORKSHOP

Collaboration is about working with one or more people to achieve a goal, such as creating content, brainstorming or evaluating options. Many organizations are looking for new ways to foster collaboration among employees. A great way to unlock collaborative potential within your organization is to understand and identify the unique ways your teams are working together today as well as capture where they see their collaborative work evolving in the near future.

The Steelcase Collaborative Situations Workshop offers a forum to identify and discuss the range of collaborative activities in your work day. Together we'll explore the ways you interact with your colleagues in both planned and unplanned sessions.

Our goal is to learn from you. As we gain an understanding of your collaborative work activities, we can consider ways that the workplace can help. Following the workshop, we will create a summary report that includes a collection of tailored thought starter applications designed to support different types of collaboration.



Our Direct Sales Office & Dealership

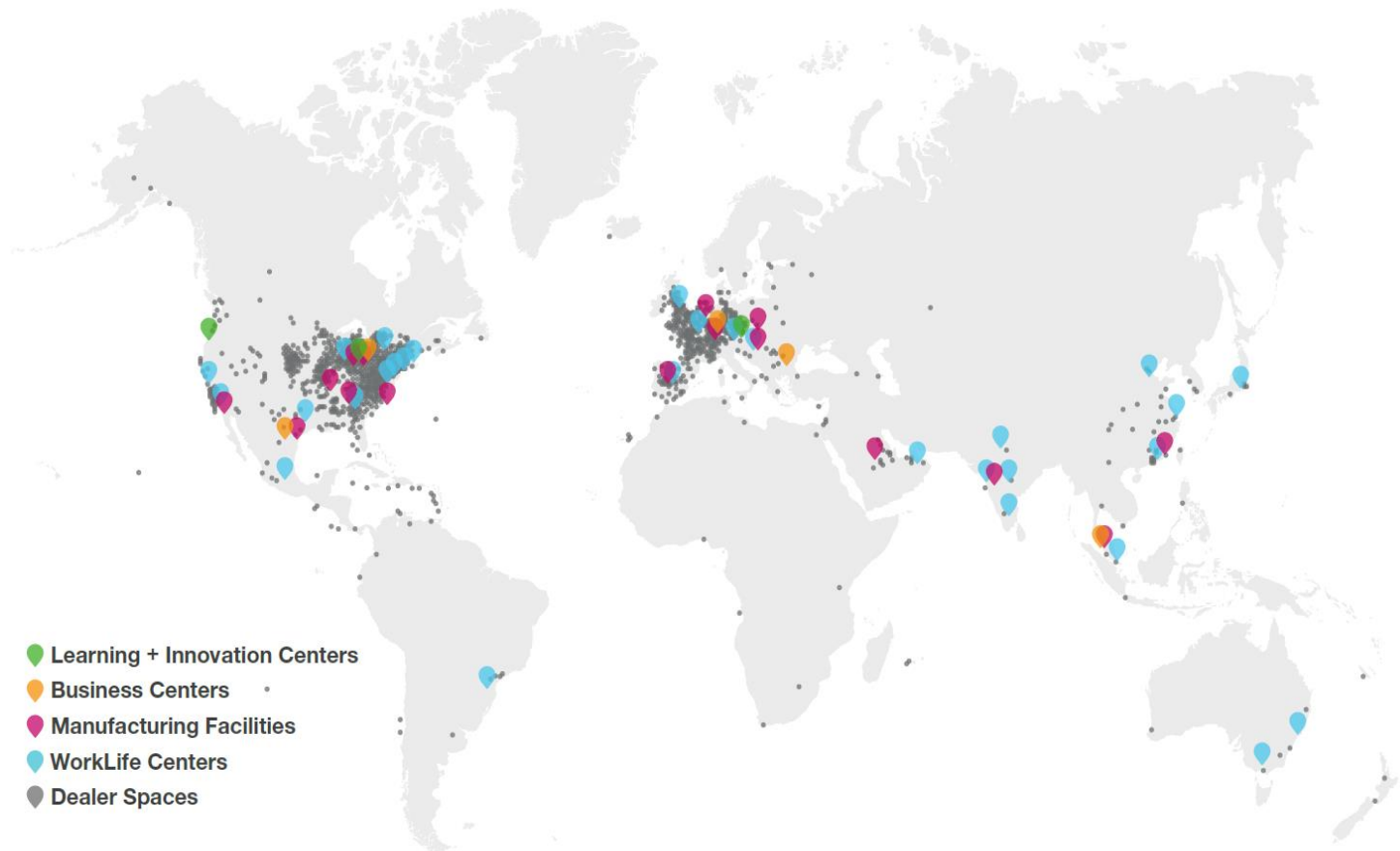
No matter where you are, it's easy to do business with Steelcase. We make our products and services available through the largest, most experienced network of dealers in the industry. The Steelcase dealer network is comprised of 650+ dealers with over 800 locations around the world. Most of our dealerships are independently owned and operated, and a few are Steelcase owned.

Dealers are committed to building long-term customer relationships, and they serve as their customers' local, first-point-of-contact for all product, service, and warranty questions and requests. As experienced business owners, dealers recognize that they can only be successful by fully meeting or exceeding their customers' needs. To that end, they are committed to providing our customers exemplary service for all of your locations.

Steelcase dealers offer local knowledge, skilled labor, workplace installation, regional asset management, and other services that may include providing audio-visual technology, floor coverings, ceilings and more to satisfy customer projects and high expectations.

Our dealer programs let you work with your local dealer on projects at multiple locations. These programs bring individual Steelcase dealerships into a unified group, with a single point of contact and consistent service no matter where your projects are located.

Direct Sales Office & Dealership Locations



APAC Direct Sales Office Locations



Delhi, India

Steelcase WorkLife Center
One Horizon Center, 11th floor
DLF City 5, Sector 43
DLF Golf Course Road
Gurgaon, Haryana 122002
India

Phone: +91.1246.1033.001



Hyderabad, India

Steelcase WorkLife Center
No.203, 2F, Silver Square
MCH No.8-2-293/82/A/714
MCH No.8-2-293/82/A/714
Hyderabad, Andhra Pradesh 500033
India

Phone: +91.0406.7046.400



Mumbai, India

Steelcase WorkLife Center
Unit 701-C, 7th Floor, Tower 2
Indiabulls Finance Center
Senapati Bapat Marg, Elphinstone Road (West) Lower Parel
Mumbai 400013
India

Phone: +91.0406.7046.400



Kuala Lumpur, Malaysia

Steelcase Office Solutions (Malaysia) Sdn Bhd
Suite 26.01 & 27.01, Level 26 & 27
The Gardens South Tower Mid Valley City
Lingkaran Syed Putra
Kuala Lumpur 59200
Malaysia

Phone: +60 3 2027 6000



Singapore

Steelcase WorkLife Center
57 Mohamed Sultan Road
Sultan-Link #02-05
Singapore 238997
Singapore

Phone: +65.673.852.25



Tokyo, Japan

Steelcase Japan WorkLife Tokyo
4F, Kowa Hiroo Bldg.
Minami-Azabu
Minato-ku
Tokyo 5-2-32
Japan

Phone: +11 81 3 3448 9611

APAC Direct + Dealership Location Capabilities

APAC Countries	With capability to delivery furniture or not?	Have already delivered any project in the past?	Through local entity or local partner?	Local partner name
China	Yes	Yes	Local Entity/Dealers	Steelcase Worklife Center. (Beijing/Shanghai) -Hangzhou Zhikai Office Furniture Co.,Ltd. -Nanjing Shi Wei Office Furniture Co., Ltd. -Shenzhen OuMei Furniture Company Ltd. -Suzhou MeiKai Office Furniture Co. Ltd. -Artnovo Systems Furniture Co. Ltd. (Zhongshan) -Shaanxi Shaking Space Planning&Construction Co.,Ltd. (Xi'an) -Yunnan Joint Office Furniture Co. Ltd. -Qingdao Fassan Environmental Project Co.Ltd.

APAC Direct + Dealership Location Capabilities

APAC Countries	With capability to delivery furniture or not?	Have already delivered any project in the past?	Through local entity or local partner?	Local partner name
Australia	Yes	Yes	Local Entity/Dealers	Steelcase Worklife Center. (Sydney/Melbourne) Inspiration Office Pty Ltd - Brisbane NineTwoFive - Canberra DesignFARM (Australia) Pty Ld - Perth
Hong Kong(China)	Yes	Yes	Local Entity	Steelcase Hong Kong Worklife Center. (Hollywood Road)
India	Yes	Yes	Local Entity	Steelcase Worklife Center. (Mumbai, New Delhi, Bangalore, Chennai, and Hyderabad)
Indonesia	Yes	Yes	Dealer	PT Vivere Multi Kreasi
Japan	Yes	Yes	Dealer	Workplace Solution.Inc (WSI), Tokyo Kurogane Kosakusho Ltd, Osaka

APAC Direct + Dealership Location Capabilities

APAC Countries	With capability to delivery furniture or not?	Have already delivered any project in the past?	Through local entity or local partner?	Local partner name
Korea.Republic of	Yes	Yes	Dealers	Frontier Workspace Solutions. - Seoul The Chair Co.Ltd. - Seoul Internmax. - Seoul
Taiwan(China)	Yes	Yes	Dealer	Fun at Work International Co. Ltd - Taipei
VietNam	Yes	Yes	Dealer	America Indochina Management Ltd
New Zealand	Yes	Yes	Dealer	Workscape Limited - Auckland
Philippines	Yes	Yes	Dealer	Ultra Modular Concepts, Inc.
Singapore	Yes	Yes	Local Entity	Steelcase Office Solutions Pte Ltd
Thailand	Yes	Yes	Dealer	Modernform Group PLC.
Myanmar	Yes	Yes	Dealer	Modernform Group PLC.
Malaysia	Yes	Yes	Local Entity	Steelcase Office Solutions (M) Sdn Bhd

APAC Direct + Dealership Location Capabilities

APAC Countries	With capability to delivery furniture or not?	Have already delivered any project in the past?	Through local entity or local partner?	Local partner name
Bangladesh	Yes	NO	Local Entity (India)	Steelcase Worklife Center. (Mumbai, New Delhi, Bangalore, Chennai, and Hyderabad)
Macao(China)	Yes	No	Local Entity	Steelcase Hong Kong Worklife Center. (Hollywood Road)
FIJI	Yes	NO	Local Entity (Australia)	Steelcase Worklife Center. (Sydney/Melbourne)
Sri Lanka	Yes	Yes	Local Entity (India)	Steelcase Worklife Center. (Mumbai, New Delhi, Bangalore, Chennai, and Hyderabad)
Brunei Darussalam	Yes	Yes	Dealer	Maya Design Sdn Bhd
Cambodia	Yes	Yes	Dealer	America Indochina Management Ltd
Lao People's Democratic	Yes	Yes	Dealer	America Indochina Management Ltd
Nepal	Yes	NO	Local Entity (India)	Steelcase Worklife Center. (Mumbai, New Delhi, Bangalore, Chennai, and Hyderabad)
Papua New Guinea	Yes	NO	Local Entity (Australia)	Steelcase Worklife Center. (Sydney/Melbourne)

APAC Dealer Network Services

Steelcase dealers are held to a **higher standard through our authorization and accreditation programs**. This helps ensure that our dealers meet or exceed your expectations – from identifying core needs and business issues to installing your furniture and completing the job on time and on budget. With such a wide range of services, wherever you are, you can rest assured that a Steelcase dealer will be there to support you, by listening and responding to your needs.

Steelcase provides many value-added services needed by customers. Our list of services includes the following:

- ✓ Specifications
- ✓ Drawings
- ✓ Order fulfillment
- ✓ Quotations
- ✓ Importation
- ✓ Local delivery
- ✓ Installation
- ✓ Maintenance
- ✓ Asset management
- ✓ Move management
- ✓ Reconfigurations

Steelcase-owned entities and authorized Steelcase dealers are responsible for coordinating every detail of your project in their respective markets to ensure a successful, on-time installation. The overall process includes:

- Pre-Order Planning
- Order Management
- Pre-delivery Planning
- Delivery
- Installation and Post-installation services
- Product Training

Plant Locations

ASIA PACIFIC (APAC)



Pune Plant, India

Steelcase Asia Pacific Holdings
India PVT.LTD (Pune)
Unit No. 1A, Building. No. 4B,
Indospace Rohan Industrial Park,
Mahalunge, G No. 428, Tal -
Khed, Dist.Pune - 410 501,
Maharashtra
5000 m²
Seating, Worksurfaces

Dongguan Plant, China

Steelcase Furniture
(Dongguan) Company Limited,
6 Lang Zhou Village, Chang
Ping Town
Dong Guan City, Guangdong
Province
2009, 21.000 m²
Panel Systems, Desking,
Worksurfaces, Melamine
pedestals, Seating

Puchong Plant, Malaysia

Steelcase Manufacturing (M)
Sdn. Bhd17, Jalan Puchong
KM 22, 47100 Puchong,
Selangor Darul Ehsan
2002, 13.000 m²
Seating, Desking, Pedestals

Shipping and Lead Times

CHINA & ASIA PACIFIC (APAC)

Proposed Ranges	Lead Times	Manufacturing Plant
Lexicon	6-8 weeks	Dongguan, China Puchong, Malaysia
FrameOne	6-8 weeks	Dongguan, China Puchong, Malaysia
Sit2Stand	6-8 weeks	Dongguan, China Puchong, Malaysia
Four Point Eight (4.8)	6-8 weeks	Dongguan, China Puchong, Malaysia
FlipTop Twin	6-8 weeks	Dongguan, China Puchong, Malaysia
Executive Collection	6-8 weeks	Dongguan, China Puchong, Malaysia
Ultra Cittern Sofa	6-8 weeks	Dongguan, China Puchong, Malaysia
media:scape Lounge	6-8 weeks	Dongguan, China Puchong, Malaysia
Bfree Lounge	6-8 weeks	Dongguan, China Puchong, Malaysia
Turnstone Campfire Lounge	6-8 weeks	Dongguan, China Puchong, Malaysia
Brody Worklounge	12-14 weeks	Import from America
Lagunitas	12-14 weeks	Import from America
SW_1 Lounge	12-14 weeks	Import from America
Campfire Big Table	6-8 weeks	Dongguan, China Puchong, Malaysia
Sebastopol	12-14 weeks	Import from America
Personality	6-8 weeks	Dongguan, China Puchong, Malaysia
Reply	6-8 weeks	Dongguan, China Puchong, Malaysia
Think	6-8 weeks	Dongguan, China Puchong, Malaysia
Leap	6-8 weeks	Dongguan, China Puchong, Malaysia
Gesture	6-8 weeks	Dongguan, China Puchong, Malaysia
Cobi	12-14 weeks	Import from America
Scoop	12-14 weeks	Import from America
Backliner	6-8 weeks	Dongguan, China Puchong, Malaysia
UPV Series	6-8 weeks	Dongguan, China Puchong, Malaysia
Datum	6-8 weeks	Dongguan, China Puchong, Malaysia
FE-1 Panels	6-8 weeks	Dongguan, China Puchong, Malaysia
AP Worktools	6-8 weeks	Dongguan, China Puchong, Malaysia

Our Sustainability



Steelcase is in the people business. While it's true we are a global leader in creating products and solutions for offices, schools, healthcare facilities and other workplaces, our larger purpose extends far beyond what we create.

We understand work is a social activity and believe it should be rewarding, fulfilling and give people a deeper sense of meaning and wellbeing. Sustainability plays a vital role in achieving that goal.

We believe sustainability is about creating the economic, social and environmental conditions that allow people and communities to thrive. We also believe it is an innovation lens and a pathway to ensuring our company is positioned to serve all of our stakeholders' needs well into the future.

This perspective influences everything we do – from the products we deliver to the research we conduct, the investments we make to the opportunities we explore. Sustainability is a systems approach to how we do business and it continues to produce results year after year.

HERE ARE SOME HIGHLIGHTS:

- Invested in renewable energy equivalent to 100 percent of our electricity use
- Expanded end of use services to help businesses redeploy assets at end of need or end of life – diverting millions of tons of furniture from the landfill and giving products new life
- Built urban school partnerships to drive educational outcomes and increased graduation rates through innovative approaches grooming tomorrow's leaders through real-world experiences
- Drove down our energy, water, and waste to meet our ambitious 2020 goals – despite expanding global production
- Launched an employee wellbeing platform that includes initiatives such as a dedicated wellbeing hub complete with nurses and coaches, generous parent bonding leave, and innovative training and development programs

Thanks for taking a look at our 2015 Corporate Sustainability Report.

A handwritten signature in black ink, appearing to read 'J. Keane'.

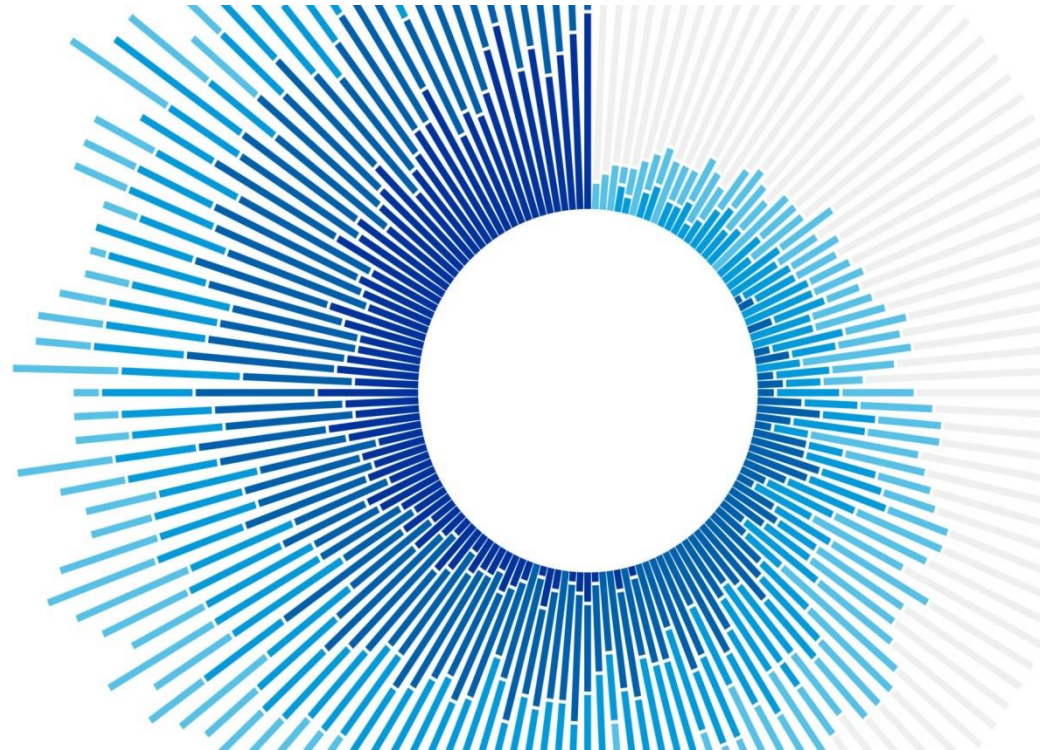
James Keane
President and CEO

Our Sustainability

Recognized Achievements 2015

Highlights from the past year that reflect the company's overall high marks include:

- Achieved a perfect score in the 2015 Corporate Equality Index, a benchmarking tool on policies and practices pertinent to lesbian, gay, bisexual and transgender employees
- Invested in renewable energy equivalent to 100% of global electricity consumption, the company continues to reduce energy, water, and waste consumption to meet ambitious 2020 goals – despite expanding global production.
- Employees offered a corporate record of service hours in the community - more than 12,000 hours.
- Received a Green Power Leadership Award from the U.S. Environmental Protection Agency (EPA) Green Power Partnership



Targets + Performances

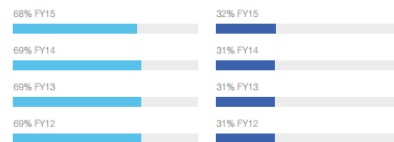
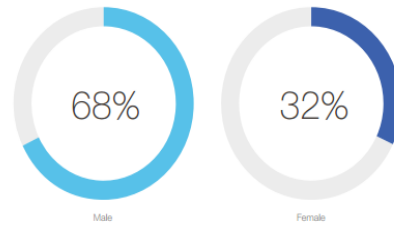
Across our global footprint, we're measuring our progress against our social, environmental and economics goals. We continuously strive to refine our metrics and expand our reporting, improving our focus on sustainability as we move toward global accuracy and amplified performance.

Social

Employee Retention



Gender Distribution



Volunteer Hours Reported



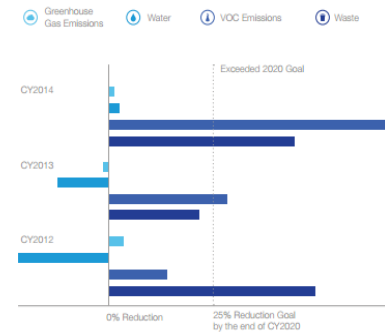
Monetary and In-kind Donations

\$3.2 Million
 Steelcase Foundation

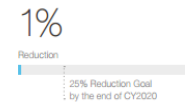
\$1.3 Million
 Steelcase Inc.

Environment

Progress Towards Goal



Greenhouse Gas Emissions



Water Use



VOC Emissions



Waste

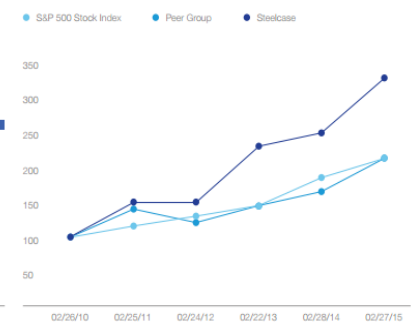


Renewable Energy

100%
 Investment in wind and hydroelectric renewable energy credits (RECs)

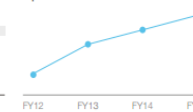
Economic

Stock Performance (\$ Dollars)



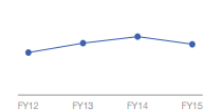
Revenue

\$3.1 Billion



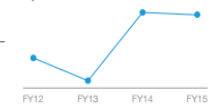
Gross Profit

30%



Net Income

\$86.1 Million



Meeting Sustainability Requirements

SUSTAINABLE PRODUCT CERTIFICATIONS

- **SCS Indoor Advantage Certification** -majority of Steelcase systems and seating are SCS Indoor Advantage Air Quality Certified
- **Cradle to Cradle Certification** - more Cradle to Cradle Certified products than any other company in any industry, globally Over 57 certificates covering 80 products groups (March 2016)
- World's first C2C certifications for the following: workstation (fully powered), chair, compostable fabric, keyboard assemblies, full height wall, and internationally certified product
- **BIFMA e3 level™ Certification** 74 BIFMA level certified products (March 2016)
- Think@-first product certified to level™ 3 (highest BIFMA e3 standard) cobio-level™ 3 certification
- **FSC Chain of Custody Certified** -wood manufacturing facility is FSC Chain of Custody certified to provide customers with FSC certified products.

SUSTAINABLE BUILDING CERTIFICATIONS AND REGISTRATIONS

Other certifications and registrations:

- ISO 9001 –14 certified facilities
- ISO 14001 –15 certified facilities
- EMAS –2 certified facilities
- OSHAS 18001 –4 certified facilities



6.3 Meeting Sustainability Requirements

SUSTAINABLE BUILDING CERTIFICATIONS AND REGISTRATIONS

LEED Certified Facilities

- Wood Products Plant, Grand Rapids, Michigan -first manufacturing facility in the world to be certified under the LEED™ Pilot Program -LEED NC Silver
- WorkLab, Grand Rapids, Michigan -LEED CI Platinum
- Steelcase Showroom, Chicago, Illinois -LEED CI Gold
- Steelcase Showroom, Washington, D.C -LEED CI Gold
- Shared Service Center, Kuala Lumpur, Malaysia -LEED Silver
- Global Headquarters Leadership Collaborative, Grand Rapids, Michigan -LEED CI Silver
- Coalesse Showroom, Chicago, Illinois -LEED CI Gold
- Designtex Showroom, Chicago, Illinois -LEED CI Gold

HEALTHY MATERIALS

Product is constructed free of environmentally hazardous materials such as PVC, CFC, solvent-based adhesives, heavy metals (chrome, lead and mercury) and benzene.

Product is constructed free of environmentally hazardous processes such as those that produce VOC's and deplete ozone.



Certifications & Warranty

We warrant that all Steelcase products are free from defects in materials and workmanship for the life of the product. This warranty is valid from date of delivery, regardless of shift usage, and covers the original purchaser for products delivered. Steelcase will repair or replace with comparable product, at its option and free of charge (for material and components) any product, part or component which fails under normal use. All our warranties are created to reflect cultural expectations for product longevity, and share commonalities in the stated exclusions and exceptions (please refer to the attached documents).

In the event you receive a Steelcase product that is freight-damaged, malfunctions, or requires warranty service, the process for placing a warranty claim is easy. Simply contact your servicing dealer or Steelcase, and we will repair or replace the product to your satisfaction.

SCS Certifications

- SCS Indoor Advantage™ - Gold certified for indoor air quality
- Cradle to Cradle™ - Silver Product Certification from MBDC
- level 1™ and level 2™ certified to BIFMA e3 standard

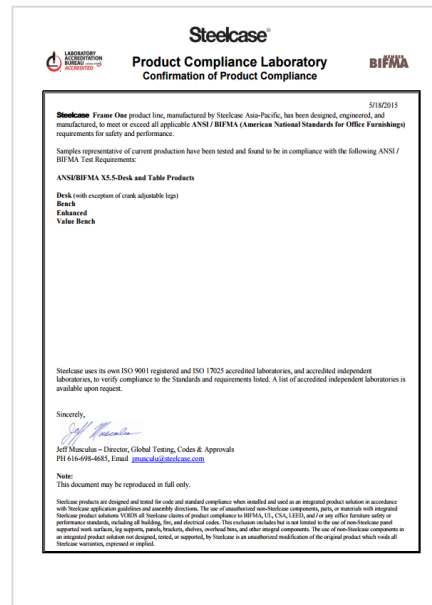
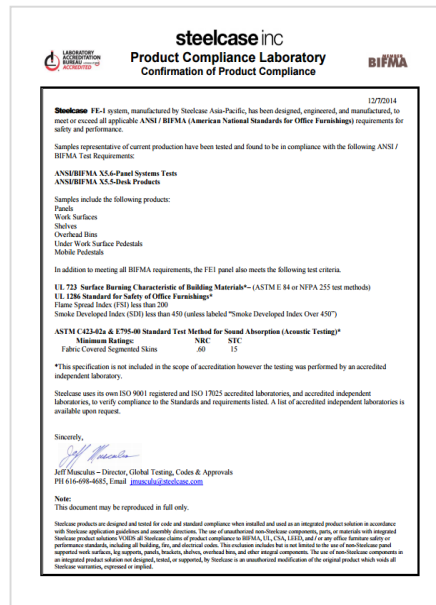


Please refer certifications documents

BIFMA Certifications

Steelcase products are designed and tested for code and standard compliance when installed and used as an integrated product solution in accordance with Steelcase application guidelines and assembly directions.

Steelcase uses its own ISO 9001 registered and ISO 17025 accredited laboratories, and accredited independent laboratories, to verify compliance to the Standards and requirements listed.



Steelcase Warranty

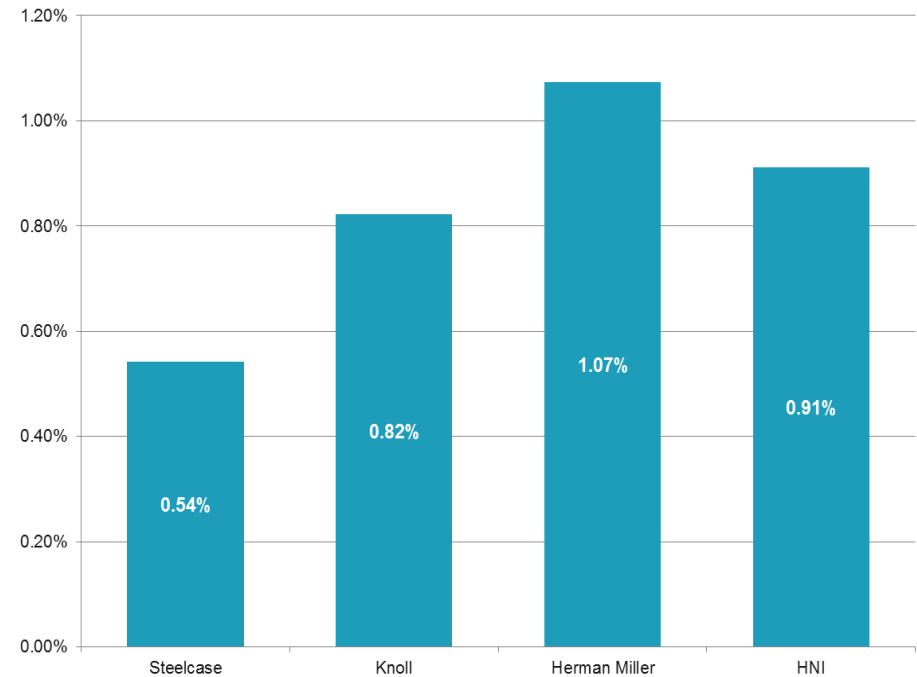
Our rigorous commitment to quality is also exemplified by the Steelcase warranty.

We Continue To Offer The Strongest Warranty In The Industry

Source: FY 2013 & FY 2014 Annual Reports and Quarterly Reports for public U.S. based companies

Methodology: warranty ratio = annual warranty accrual / annual sales revenue. 2013 presentation calculations used settlement data, whereas this slide uses accrual data, which more accurately reflects activity from the most current period.

Sources: Steelcase 2/28/2014 Annual Report, Knoll 12/31/2013 Annual Report, Herman Miller 5/31/2014 Annual Report, HNI 9/27/2014 Quarterly Report (9 months of data)



Discounts & Pricing

Thank You

Steelcase